

Installation guide
Guia de instalação

Notice d'installation
Installationsanvisningar

Montagehandleiding
Installasjonsanvisninger

Gebrauchsanweisung
Monteringsvejledninger

Guida all'installazione
Asennusohjeet

Guía de instalación
Οδηγός εγκατάστασης

OXIMO RTS

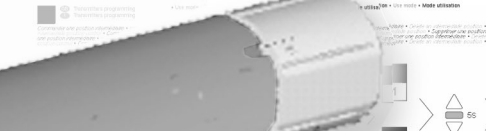
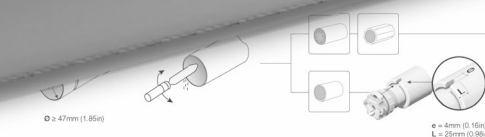
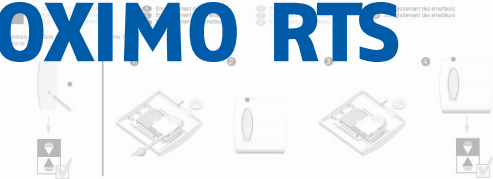

Réf.5005319A

SOMFY

GB Before installation, please read carefully the safety instructions on the sheet included.

The failure to respect these instructions annuls Somfy's responsibility and guarantee. Somfy cannot be held responsible for any changes in norms and standards introduced after the publication of this guide.

F Avant la mise en œuvre veuillez lire les instructions de sécurité ci-jointes.

Le non-respect de ces instructions annule la responsabilité de SOMFY et sa garantie. SOMFY ne peut être tenue responsable des changements de normes et standards intervenus après la publication de cette notice.

NL Lees de bijgevoegde veiligheidsinstructie s.v.p. aandachtig door voordat u begint met de installatie.

Door het niet respecteren van deze instructies vervalt de garantie en de verantwoordelijkheid van Somfy. Somfy is niet verantwoordelijk voor veranderingen in normen en standaarden die tot stand zijn gekomen na de publicatie van deze montagehandleiding.

D Vor Inbetriebnahme unbedingt die Sicherheitsanweisungen auf beiliegendem Blatt beachten. Bei Nichtbeachten der Gebrauchsanweisung entfällt die Somfy Gewährleistung. Somfy ist nicht haftbar für Änderungen der Normen und Standards nach Erscheinen der Gebrauchsanweisung.

I Prima dell'installazione per favore leggere attentamente le istruzioni di sicurezza sul foglio allegato.

Il mancato rispetto di queste istruzioni annulla la responsabilità e la garanzia SOMFY. SOMFY non può essere ritenuta responsabile per qualsiasi cambiamento alle norme e agli standards introdotti dopo la pubblicazione di questa guida.

E Antes de realizar la instalación, leer cuidadosamente las instrucciones de seguridad adjuntas.

La responsabilidad y garantía de SOMFY quedan anuladas en caso de incumplimiento de estas instrucciones. SOMFY no se hace responsable de los cambios en la normativa introducidos después de la publicación de esta guía.

P Antes da instalação, por favor leia com cuidado as instruções incluídas na folha.

O não respeito às instruções neste manual exclui toda a responsabilidade e garantia por parte da Somfy. Somfy não poderá ser responsabilizada por eventuais alterações normativas, posteriores à edição deste manual.

S Innan installation, läs noga genom säkerhetsföreskrifterna på det medföljande bladet.

Om dessa föreskrifter inte följs upphör Somfys ansvar och garanti. SOMFY kan inte hållas ansvarig för förändringar i normer och standarder som införs efter att dessa anvisningar publicerats.

N Før innstallasjon. Les nøye gjennom sikkerhetsforskrifterne på det vedlagte arket.

Dersom disse forskrifter ikke blir fulgt, opphører Somfys ansvar og garanti. SOMFY kan ikke stilles til ansvar for forandringer i normer og standarder som innføres etter at disse anvisningene er publisert.

DK Før installation, gennemlæs grundigt sikkerhedsinstruktionerne på det medfølgende ark.

Hvis disse forskrifter ikke følges, bortfalder Somfys ansvar og garanti. SOMFY kan ikke holdes ansvarlig for ændringer i normer og standarder, som indføres efter, at denne vejledning er offentliggjort.

SF Ennen asennuksen aloittamista lue huolellisesti liitteessä olevat turvallisuusohjeet.

Jos näitä määräyksiä ei noudateta, Somfyn vastuu ja takuu raukeavat. SOMFYa ei voida asettaa vastuuseen näiden ohjeiden julkistamisen jälkeisestä normien ja standardien muutoksista.

GR Πριν την εγκατάσταση, παρακαλώ διαβάστε προσεκτικά της οδηγίες ασφαλείας που εμπεριέχονται σε αυτό το έντυπο.

Η παράλειψη τήρησης των οδηγιών, αφαιρεί την υπευθυνότητα και ταυτόχρονα ακυρώνει την εγγυήση της Somfy. Η Somfy δεν θα θεωρηθεί υπεύθυνη για οποιαδήποτε αλλαγή των νόμων και κανονισμών που θα πρωτοπαρουσιασθούν μετά από την έκδοση αυτού του εντύπου.

CONTENTS • SOMMAIRE • INHOUDSOPGAVE • INHALTSVERZEICHNIS

1	Motor mounting Programming hand-held transmitter	Montage du moteur Enregistrement de la télécommande	Montage van de motor Programmeren van de afstandsbediening	Antriebsmontage Einlernen eines Senders
2	Intermediate position operating	Utilisation de la position intermédiaire	Werking tussenpositie	Frei wählbare Zwischenposition
3	Add or delete a control in the memory of motor	Ajout ou suppression d'un émetteur dans la mémoire moteur	Een afstandsbediening in het motorgeheugen toevoegen of wissen	Weitere Sender einlernen oder löschen
4	Replacement of a lost remote control	Remplacement d'un émetteur perdu	Vervangen van een verloren bedieningspunt	Ersetzen eines verlorenen Senders
5	Erase the motor's memory	Effacement complet de la mémoire moteur	Volledig wissen van het motorgeheugen	Zurücksetzen in Auslieferungszustand
6	Re-adjust the end limits	Ré-ajustement des fins de course	Bijstellen van de eindposities	Ändern der Endlagen
7	Trouble shooting	Dépannage	Verhelpen van storingen	Abhilfe bei Störungen

SOMMARIO • INDICE • INDICE • INNEHÅLL

1	Montaggio del motore Programmazione del telecomando	Montaje del motor Programación del emisor	Montagem do motor Programação do comando à distância	Montering av motor Programera fjärrkontrollen
2	Comando della posizione intermedia	Programación de la posición intermedia	Programação do ponto intermédio	Använda mellanläget
3	Aggiungere o cancellare un comando nella memoria del motore	Añadir o borrar un emisor de la memoria del operador	Adicionar o apagar um emissor da memória do motor	Användning av mellanstopp
4	Sostituzione di un telecomando perso	Reemplazar un emisor perdido	Substituição de um emissor perdido	Ersättning av borttappad sändare
5	Cancellare memoria del motore	Borrar de la memoria del operador	Apagar da memoria do operador	Radera all programmering
6	Reprogrammazione dei fine corsa	Reajuste de los finales de carrera	Reajuste dos fins de curso	Omjustering av gränslägen
7	Risoluzione dei problemi	Reparación	Desempanagem	Felsökning

INNHold • INDHOLD • SISÄLTÖ • ΠΕΡΙΕΧΟΜΕΝΑ

1	Montering av motor Programmering av fjernkontrollen	Montering af motor Programmering af fjernbetjeningen	Moottorin asennus Kaukosäätimen ohjelmointi	Τοποθέτηση μοτέρ Προγραμματισμός του τηλεχειριστηρίου
2	bruk av mellomstopp	Brug af mellemstop	Väljasennon käyttö	Χρήση της ενδιάμεσης θέσης
3	Legge til eller ta bort en sender i minnet	Tilføjelse eller fjernelse af en sender i motorens hukommelse	Lähettimen lisääminen tai poistaminen	Προσθήκη ή κατάργηση ενός πομπού από τη μνήμη του μοτέρ
4	Erstatning av mistet sender	Udskiftning af mistet sender	Kadotetun lähettimen korvaaminen	Αντικατάσταση ενός χαμένου τηλεχειρισμού
5	slette all programering	Slet motorens hukommelse	Moottorin muistin tyhjennys	Διαγραφή της μνήμης του μοτέρ
6	omjustering av endebrytere	Efterjustér endestop	Rajojen uudelleen säätö	Διόρθωση των ορίων
7	Feilsøking	Fejlfinding	Vian etsintä	Προβλήματα λειτουργίας

- GB** Compatible RTS controls
- I** Trasmittitori compatibili
- N** Manøvrering av motoren med sender

- F** Pour télécommander votre moteur
- E** Emissores compatibles
- DK** Manøvrering af motoren med sender

- NL** Uw motor draadloos bedienen
- P** Para controlar com um emissor o seu operador
- SF** Moottorin ohjaus lähettimellä

- D** Kompatible Sender
- S** Manøvrering av motorn med sändare
- GR** Συμβατά τηλεχειριστήρια RTS

Telis RTS - Telis RTS silk - Telis RTS patio



Centralis RTS - Chronis RTS - Inis RT

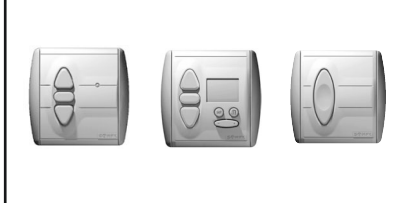

Memory capacity • *Capacité mémoire* • *Geheugencapaciteit* • max. 12 Funksender
Capacità di memoria • *Capacidad de memoria* • *Capacidade de memória* • *Minneskapacitet*
Minnekapasitet • *Hukommelseskapacitet* • *Muistikapasiteetti* • *Χωρητικότητα μνήμης*



12

Radio Technology **Somfy**™

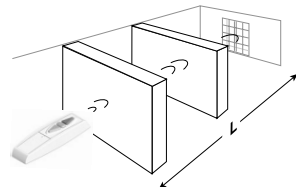

	L)))
Telis RTS	20 m / 65 ft	433,42 MHz
Centralis RTS Chronis RTS		
Inis RT	6 m / 19 ft	
Telis RTS U.S.		

- GB** Symbols used in this booklet
- I** Simbologia utilizzata nel manuale
- N** Symboler som benyttes i hæftet

- F** Symboles utilisés dans votre notice
- E** Símbolos utilizados en esta guía
- DK** Symboler, der anvendes i hæftet

- NL** Gebruikte symbolen in de montagehandleiding
- P** Símbolos utilizados no seu guia
- SF** Esitteessä käytetyt tunnukset

- D** Verwendete Symbole
- S** Symboler som används i hæftet
- GR** Σύμβολα που χρησιμοποιούνται στο εγχειρίδιο

Actions • *Les actions* • *Acties* • *Bedienung* • *Gli azionamenti* • *Acciones* • *Acções* • *Manövrering* • *Manøvrering* • *Manøvrering* • *Toiminnan säätö* • *Ενέργειες*



Up • *Montée* • **Op** • *AUF* • *Salita* • *Subida* • *Subida* • *Upp* • *Opp* • *Op* • *Ylös* • Πάνω



Stop • *Arrêt* • *Stop/TP* • **STOP** • *Stop* • *Stop* • *Stop* • *Stopp* • *Stopp* • *Stop* • *Seis* • ΣΤΟΠ



Down • *Descente* • **Neer** • *AB* • *Discesa* • *Bajada* • *Descida* • *Ned* • *Ned* • *Ned* • *Alas* • Κάτω



Press simultaneously • *Appui simultané* • **Tegelijk indrukken** • *Gleichzeitig drücken* • *Pressione simultanea* • *Pulsar simultáneamente* • *Premir simultáneamente* • *Samtidig trykning* • **Trykk samtidig** • *Samtidig trykning* • *Samanaikainen painallus* • Ταυτόχρονη πίεση



Command duration • *Temps d'appui* • *Tijdsduur van het indrukken* • *Zeitangaben* • *Tempo di azione sul pulsante* • *Tiempo de pulsación* • *Tempo de pressão* • *Nedtrykningstider* • *Inntrykkingstid* • *Nedtrykningstider* • *Alaspainallusajat* • Διάρκεια πίεσης

2 s-5 s-7 s

Hold down time • *Maintien minimal* • *Tijdsduur van het indrukken* • *Drücken für x Sekunden* • *Premere almeno per* • *Mantener pulsado* • *Manter premido* • *Hålltid* • *Holdetid* • *Holdetid* • *Pidätysaika* • Παρατεταμένη πίεση

0,5 s

Press briefly • *Appui bref* • *Kort indrukken* • *kurz drücken* • *Impulso breve* • *Pulsación breve* • *Pressão breve* • *Kortvarigt tryk* • *Kort trykk* • *Kortvarigt tryk* • *lyhyt painallus* • Σύντομη πίεση



Executed setting • *Réglage terminé* • **Posities zijn ingesteld** • *Einstellung abgeschlossen* • *Regolazione terminata* • *Programación correcta* • **Programação correcta** • *Inställningen är slutförd* • **Innstillingen er utført** • *Indstillingen er gennemført* • **Asetukset ovat valmiit** • Εκτέλεση ρύθμισης

- GB** Symbols used in this booklet
- I** Simbologia utilizzata nel manuale
- N** Symboler som benyttes i hæftet

- F** Symboles utilisés dans votre notice
- E** Símbolos utilizados en esta guía
- DK** Symboler, der anvendes i hæftet

- NL** Gebruikte symbolen in de montagehandleiding
- P** Símbolos utilizados no seu guia
- SF** Esitteessä käytetyt tunnukset

- D** Verwendete Symbole
- S** Symboler som används i hæftet
- GR** Σύμβολα που χρησιμοποιούνται στο εγχειρίδιο

End-product status • Etat du produit porteur • Positie van het eindproduct • Behang Status • Stato del prodotto portante • Estado del producto portador • Situação do produto portador • Solskyddets status • S olbeskyttelsens status • Solafskærmningens status • Aurinkosuojan tila • Ισχύουσα κατάσταση τελικού προϊόντος



Low position • Position basse • **Laagste positie** • Untere Position • **Fine corsa basso** • Posición baja • **Posição baixa** • Helt nedkört • **Kjørt helt ut** • Kjørt helt ned • **Aivan ala-asennossa** • Ανώτατη θέση



High position • Position Haute • **Hoogste positie** • Obere Position • **Fine corsa alto** • Posición alta • **Posição alta** • Helt uppkört • **Kjørt helt inn** • Kjørt helt op • **Aivan yläasennossa** • Κατώτατη θέση



Stop at the required position • Arrêt à la position souhaitée • **Stop op de gewenste positie** • Stoppen bei der gewünschten Position • **Arresto alla posizione desiderata** • Parar en la posición deseada • **Parar na posição desejada** • Stoppa vid önskat läge • **Stopp ved ønsket posisjon** • Stop i ønsket stilling • **Haluttuun asentoon pysäyttämisen** • Σταμάτημα στη ζητούμενη θέση



Intermediate position • Position intermédiaire • **Tussenpositie (TP)** • IP / Zwischenposition • **Posizioni intermedie** • Posición intermedia • **Posições intermédias** • Mellanstopp • **mellomstopp** • Mellemstop • **Väliasento** • Ενδιάμεση θέση



Short up & down movement • Bref mouvement (bonne réception) • **Korte OP en NEER beweging** • Kurze Auf / Ab Bewegung • **Breve movimento di salita e discesa** • Breve movimiento (arriba/abajo) • **Breve movimento (cima/abaixo)** • Kort upp- och nedrörelse • **Kort bevegelse opp og ned** • Kort op- og nedbevegelse • **lyhyt liike ylös ja alas** • Σύντομη κίνηση πάνω & κάτω



Up • Montée • **Op** • AUF Bewegung • **Salita** • Subida • **Subida** • Upp • **Opp** • Op • **Ylös** • Πάνω



Down • Descente • **Neer** • AB Bewegung • **Discesa** • Bajada • **Descida** • Ned • **Ned** • Ned • **Alas** • Κάτω

1

2

3

4

5

6

7

- GB Tube preparation
- I Preparazione del tubo
- N Forbedredelse av rør

- F Préparation du tube
- E Preparación del tubo
- DK Bearbejdning af rør

- NL Oprolbuis gereedmaken
- P Preparação do tubo
- SF Putkien käsittely

- D Vorbereitung der Welle
- S Bearbetning av rör
- GR Προετοιμασία σωλήνα.

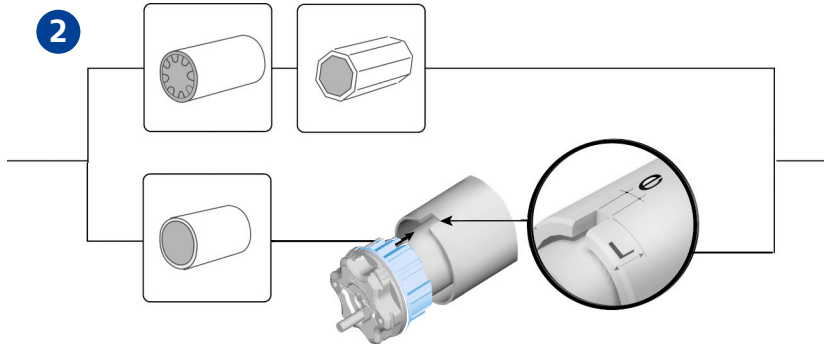
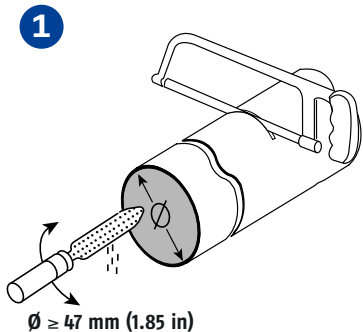

1

- GB Motor mounting
- I Montaggio del motore
- N Montering av motoren i rör

- F Assemblage du moteur
- E Montaje del operador
- DK Montering af motoren i rør

- NL Buismotor monteren
- P Montagem do operador
- SF Moottorin asentaminen putkeen

- D Antriebsmontage
- S Montering av motorn i rör
- GR Τοποθέτηση μοτέρ.

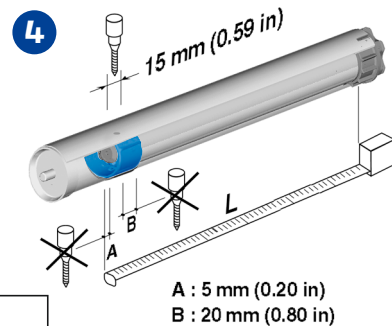
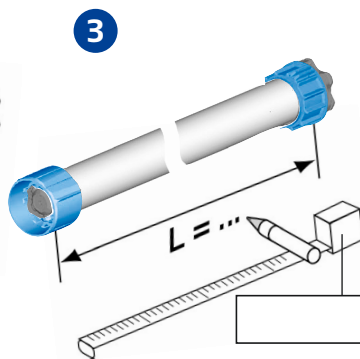
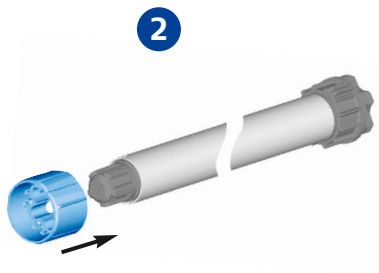
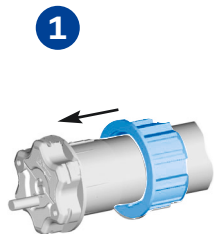

1

- GB** Install the tube on the brackets
- I** Fissaggio del tubo ai suoi supporti
- N** Montering av motor og rør på motorfeste og endebeslag

- F** Installer le tube sur ses supports
- E** Instalar el tubo en los soportes
- DK** Montering af motor & rør på motorbeslag og endebeslag

- NL** Oprolbuis monteren
- P** Instalar o tubo nos suportes
- SF** Moottorin ja putkien asennus moottorikiinnikkeeseen ja päätyheloihin

- D** Montage der Welle in die Lager
- S** Montering av motor & rör på motorfäste och ändbeslag
- GR** Τοποθετήστε τον σωλήνα στα στηρίγματα.

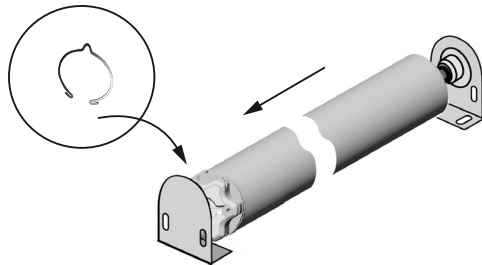
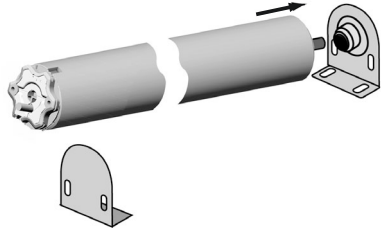
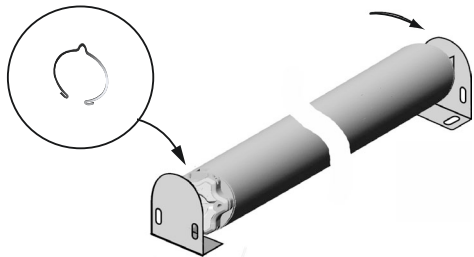

- GB** Power supply and wiring
- I** Alimentazione e cablaggio
- N** Elektrisk installasjon

- F** Alimentation et câblage
- E** Alimentación y cableado
- DK** Elektrisk installation

- NL** Buismotor op lichtnet aansluiten
- P** Alimentação e cablagem
- SF** Sähköasennukset

- D** Stromversorgung und Klemmenbelegung
- S** Elektrisk installation
- GR** Παροχή ρεύματος και καλωδίωση

1

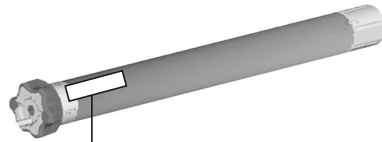

230 V / 50 Hz

1	Live · phase · Phase · Fase fase · fase · live · fas · fase fase · vaihe · Φάση	Brown · Marron · Bruin · Braun Marrone · Marrón · Castanho · Brun Brun · Brun · Ruskea · Καφέ
2	Neutral · neutre · nul · Neutraleiter neutro · neutro · neutro · nolla null · nul · nolla · Ουδέτερος	Blue · Bleu · Blau · Blauw Blu · Azul · Azul · Biał Biał · Biał · Sininen · Μπλε
3	Earth · terre · Aarde · Erde · terra tierra · terra · jord · jord · jord Maadoitus · Γείωση	Green-yellow · Vert-jaune · Geel/groen · Gelb-Grün Giallo/verde · Verde-amarillo · Verde-amarelo Grøn/gul · Grønn/gul · Grøn/gul · Vihreä/keltainen Πράσινο-κίτρινο

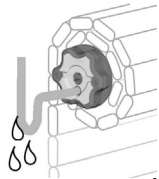
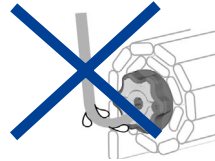
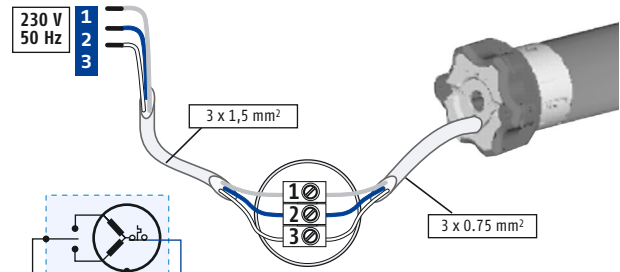

4

- GB** Programming the direction of rotation
I Programmazione del senso di rotazione
N Programmering av rotasjonsretning

- F** Programmation du sens de rotation
E Programación del sentido de rotación
DK Programmering af rotationsretning

- NL** Draairichting instellen
P Programação do sentido de rotação
SF Pyörimissuunnan ohjelmointi

- D** Drehrichtung einstellen
S Programmering av rotationsriktning
GR Προγραμματισμός κατευθύνσεως της περιστροφής.

1

GB If the installation is made up of several OXIMO RTS, only one OXIMO RTS motor must be powered during programming. This will avoid interference with the first programming of each OXIMO RTS motor.

F Si l'installation comporte plusieurs OXIMO RTS, un seul moteur doit être alimenté pendant la phase de programmation. Ceci évitera les interférences avec les autres moteurs lors de la première programmation.

NL Bij het programmeren van meerdere Oximo RTS buismotoren mag slechts één motor tegelijkertijd van spanning voorzien worden. Dit voorkomt verstoring van eerdere programmeringswerkzaamheden.

D Wenn die Installation für mehrere Antriebe vorgenommen werden soll, muß darauf geachtet werden, dass während des einlernens des Senders immer nur der zu programmierende Antrieb mit Netzspannung versorgt wird.

I Se l'installazione viene eseguita con più operatori OXIMO RTS, alimentare sempre un solo operatore per volta. Questo eviterà interferenze tra i motori OXIMO RTS durante la programmazione.

E Si la instalación está compuesta de varios OXIMO RTS, sólo un OXIMO RTS debe ser alimentado durante la programación. Esto evitará interferencias en la primera programación de cada operador OXIMO RTS.

P Se a instalação é composta por vários OXIMO RTS, só um OXIMO RTS deve ser alimentado durante a programação. Isto evitará interferências na primeira programação de cada operador OXIMO RTS.

S Om installationen består av flera OXIMO RTS, skall bara en OXIMO RTS-motor åt gången vara ansluten till spänningskälla under programmeringen. Detta för att undvika störningar vid den första programmeringen av varje OXIMO RTS-motor.

N Dersom installasjonen består av flere OXIMO RTS, skal kun en OXIMO RTS-motor om gangen være koblet til spenningskilde ved programmeringen. Dette for å unngå forstyrrelser ved den første programmeringen av hver OXIMO RTS-motor.

DK Hvis installationen består af flere OXIMO RTS, skal kun én OXIMO RTS-motor ad gangen være tilsluttet strøm under programmeringen. Dette for at undgå forstyrrelser ved den første programmering af hver enkelt OXIMO RTS-motor.

SF Jos asennukseen kuuluu usea OXIMO RTS, vain yksi OXIMO RTS -moottori kerrallaan saa olla yhdistettynä virtalähteeseen ohjelmoinnin aikana. Näin vältetään häiriöt jokaisen OXIMO RTS -moottorin ensimmäisen ohjelmoinnin aikana.

GR Εάν η εγκατάσταση έχει γίνει από πολλά μοτέρ OXIMO RTS, μόνο ένα μοτέρ OXIMO RTS πρέπει να παίρνει παροχή κατά τον προγραμματισμό. Με αυτό θα αποφευχθούν οι παρεμβολές του πρώτου προγραμματισμού για κάθε μοτέρ OXIMO RTS

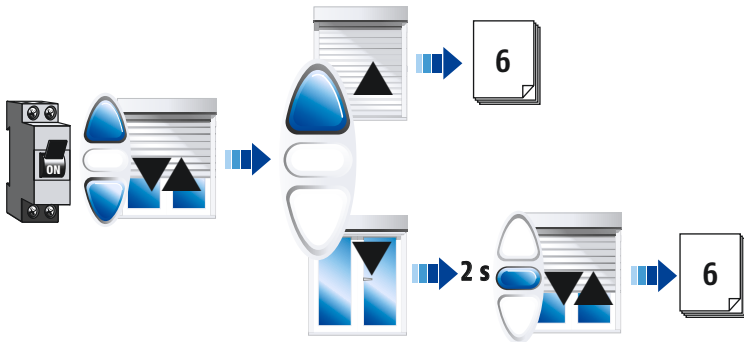

2

3

4

5

6

7

5

- GB** End limits adjustment
- I** End limits adjustment
- N** justering av endebyrtere

- F** réglage des fins de courses
- E** Ajuste de los finales de carrera
- DK** Indstilling af endestop

- NL** Instellen van de eindposities
- P** Regulação dos fins de curso
- SF** Rajojen säätö

- D** Möglichkeiten der Endlageneinstellung
- S** Inställning av gränslägen
- GR** Ρύθμιση των ορίων

1

2

3

4

5

6

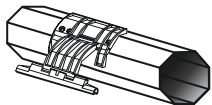

A



7

B



8

C



9

D



10

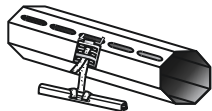

- 1
- 2
- 3
- 4
- 5
- 6
- 7
- GB End limits adjustment
 - I Regolazione dei fine corsa
 - N justering av endebrytere

- F réglage des fins de courses
- E Ajuste de los finales de carrera
- DK Indstilling af endestop

- NL Instellen van de eindposities
- P Regulação dos fins de curso
- SF Rajojen säätö

- D Endlagen - feste Verbinder / Stopper
- S Inställning av gränslagen
- GR Ρύθμιση των ορίων

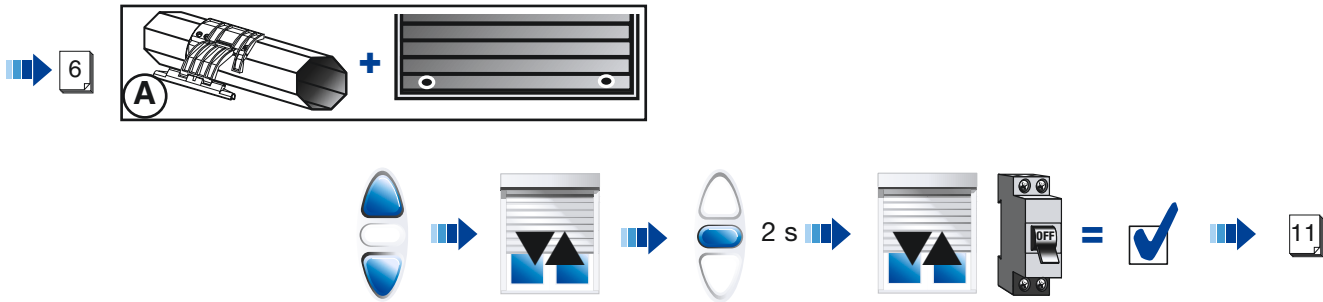

- GB** End limits adjustment
- I** Regolazione dei fine corsa
- N** justering av endebytere

- F** réglage des fins de courses
- E** Ajuste de los finales de carrera
- DK** Indstilling af endestop

- NL** Instellen van de eindposities
- P** Regulação dos fins de curso
- SF** Rajojen säätö

- D** Endlagen - feste Verbinder / Keine Stopper
- S** Inställning av gränslägen
- GR** Ρύθμιση των ορίων

1

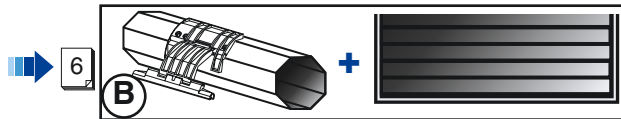

2

3

4

5

6

7



1
2
3
4
5
6
7

GB End limits adjustment
I Regolazione dei fine corsa
N justering av endebrytere

F réglage des fins de courses
E Ajuste de los finales de carrera
DK Indstilling af endestop

NL Instellen van de eindposities
P Regulação dos fins de curso
SF Rajojen säätö

D Endlagen - Flexible Verbinder / Stopper
S Inställning av gränslägen
GR Ρύθμιση των ορίων

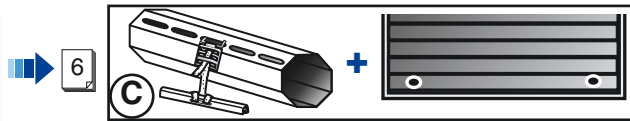

- GB** End limits adjustment
- I** Regolazione dei fine corsa
- N** justering av endebrytere

- F** réglage des fins de courses
- E** Ajuste de los finales de carrera
- DK** Indstilling af endestop

- NL** Instellen van de eindposities
- P** Regulação dos fins de curso
- SF** Rajojen säätö

- D** Endlagen - Flexible Verbinder / Keine Stopper
- S** Inställning av gränslägen
- GR** Ρύθμιση των ορίων

1

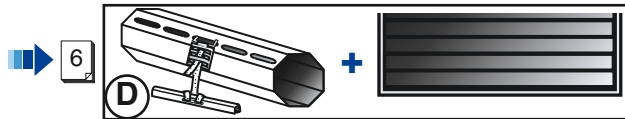

2

3

4

5

6

7

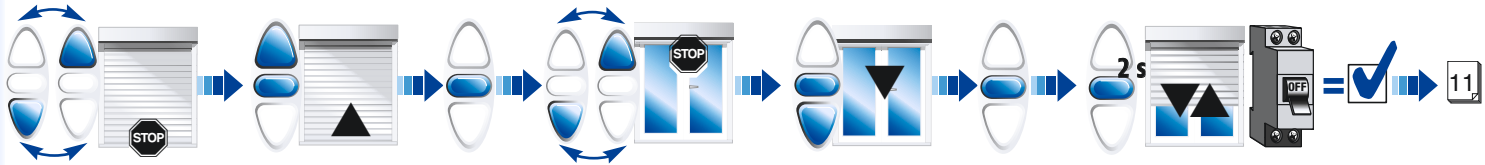

1
2
3
4
5
6
7

- GB Programming the first transmitter
- I Programmazione del primo trasmettitore
- N programering av handsender ved installasjon

- F Enregistrement du premier émetteur
- E Programación del primer emisor
- DK Programmering af sendere ved installation

- NL Programmeren van de eerste zender
- P Programar o primeiro emissor
- SF Ensimmäisen lähettimen ohjelmointi

- D Einlernen des ersten Senders
- S Programmering av sändare vid installation
- GR Προγραμματισμός του πρώτου τηλεχειρισμού

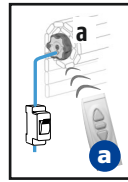
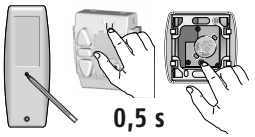
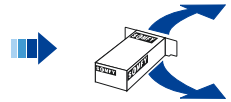
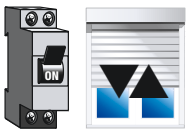
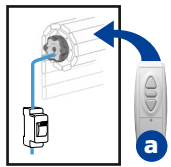

- GB Intermediate position control
- NL Tussenpositie oproepen
- N Bruk av utfallsposisjon
- I Comando della posizione intermedia
- P Atinjir uma posição intermédia
- SF Väliasennon käyttö

- F Commander la position intermédiaire
- E Alcanzar una posición intermedia
- DK Anvendelse af udfældet position
- D Bedienergonomie Zwischenposition
- S Användning av utfallsläge
- GR Έλεγχος ενδιάμεσης θέσης

- GB Recording or changing intermediate position
- NL Programmeren of wijzigen van de tussenpositie
- N Programmering eller endring av mellomposisjonen
- I Programmazione o modifica della posizione intermedia
- P Programação ou alteração da posição intermédia
- SF Väliasennon tallentaminen tai muuttaminen

- F Enregistrement ou modification de la position intermédiaire
- E Memorizar o cambiar la posición intermedia
- DK Programmering eller ændring af den mellemste position
- D Speichern oder ändern Zwischenposition
- S Programmera eller förändra mellanläget
- GR Προγραμματισμός ή αλλαγή της ενδιάμεσης θέσης

1

2

3

4

5

6

7

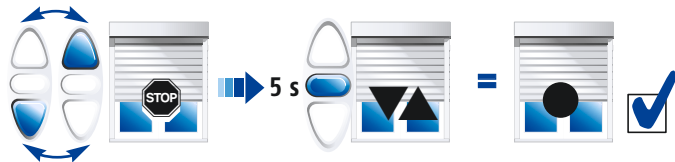
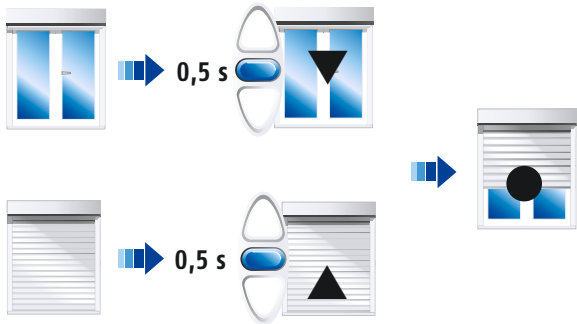

- GB Delete an intermediate position
- I Cancellazione di una posizione intermedia
- N Slette en utfallsposisjon

- F Suppression de la position intermédiaire
- E Borrar la posición intermedia
- DK Sletning af en udfældet position

- NL Wissen van een tussenpositie
- P Apagar a posição intermédia
- SF Väliasennon poistaminen

- D Löschen der Zwischenposition
- S Radera ett utfallsläge
- GR Διαγραφή ενδιάμεσης θέσης

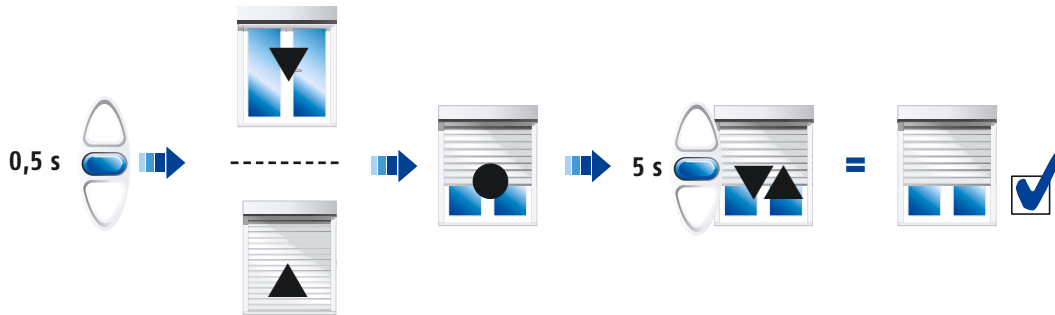

- GB** Add a control in the memory of motor
- I** Aggiungere o cancellare un comando nella memoria del motore
- N** legge til en sender

- F** Ajout d'un émetteur dans la mémoire moteur
- E** Añadir o borrar un emisor de la memoria del operador
- DK** Lægge en sender til

- NL** Toevoegen van een bedieningspunt
- P** Adicionar ou apagar um emissor da memória do operador
- SF** Lähettimen lisääminen

- D** Weitere Sender einlernen
- S** Lägga till en sändare
- GR** Πρόσθεση ή αφαίρεση τηλεχειρισμού προς/από τη μνήμη του μοτέρ.

1

2

3

4

5

6

7

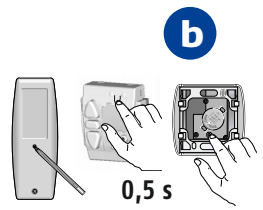
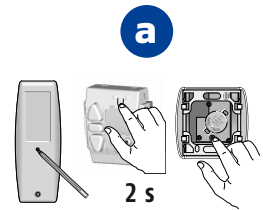
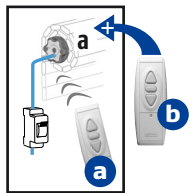

- GB** Delete a control in the memory of motor
- I** Cancellare un comando nella memoria del motore
- N** radere en sender

- F** Suppression d'un émetteur dans la mémoire moteur
- E** Añadir o borrar un emisor de la memoria del operador
- DK** Slet en sender

- NL** Wissen van een bedieningspunt
- P** Adicionar ou apagar um emissor da memória do operador
- SF** Lähettimen poistaminen

- D** Einen Sender löschen
- S** Radera en sändare
- GR** Πρόσθεση ή αφαίρεση τηλεχειρισμού προς/από τη μνήμη του μοτέρ.

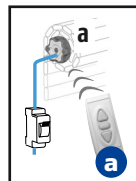
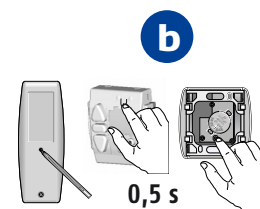
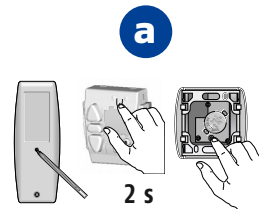
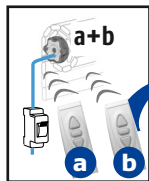

- GB** Replacement of a lost remote control
- I** Sostituzione di un telecomando perso
- N** Erstatning av mistet sender

- F** Remplacement d'un émetteur perdu
- E** Reemplazar un emisor perdido
- DK** Udskiftning af mistet sender

- NL** Vervangen van een verloren bedieningspunt
- P** Substituição de um emissor perdido
- SF** Kadotetun lähettimen korvaaminen

- D** Ersetzen eines verlorenen Senders
- S** Ersättning av borttappad sändare
- GR** Αντικατάσταση ενός χαμένου τηλεχειρισμού

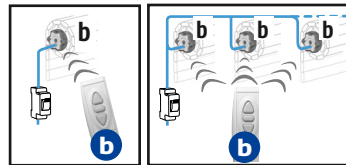
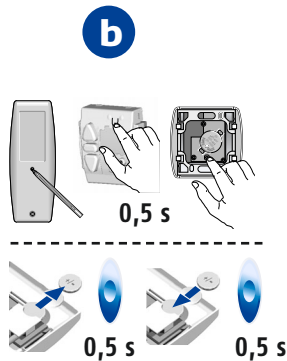
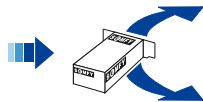
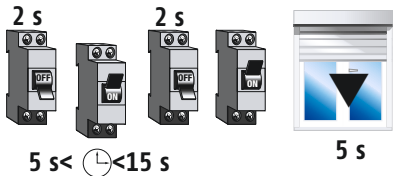
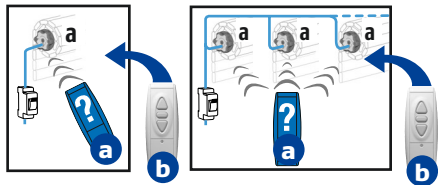

- GB** Replacement of a lost remote control
- I** Sostituzione di un telecomando perso
- N** Erstatning av mistet sender

- F** Remplacement d'un émetteur perdu
- E** Reemplazar un emisor perdido
- DK** Udskiftning af mistet sender

- NL** Vervangen van een verloren bedieningspunt
- P** Substituição de um emissor perdido
- SF** Kadotetun lähettimen korvaaminen

- D** Ersetzen eines verlorenen Senders
- S** Ersättning av borttappad sändare
- GR** Αντικατάσταση ενός χαμένου τηλεχειρισμού

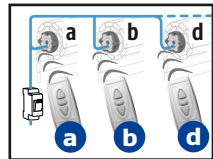
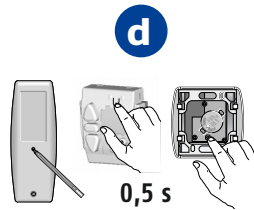
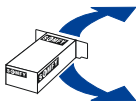
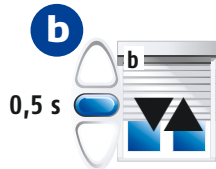
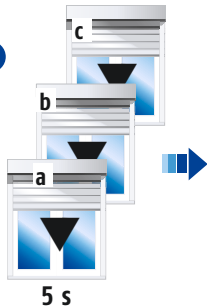
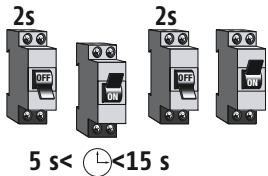
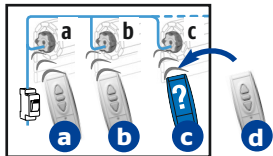

- GB** Erase the memory of motor
- I** Cancellare memoria del motore
- N** total radering av motorens minne

- F** Effacement complet de la mémoire moteur
- E** Reset (puesta a cero del operador)
- DK** Total sletning af motorens hukommelse

- NL** Volledig wissen van het motorgeheugen
- P** Apagar a memoria do operador
- SF** Moottorin muistin tyhjennys

- D** Zurücksetzen aller Motoren in Auslieferungszustand
- S** Total radering av motors minne
- GR** Διαγραφή της μνήμης του μοτέρ

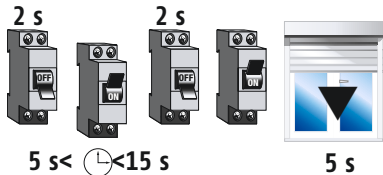
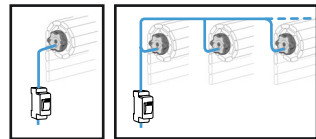
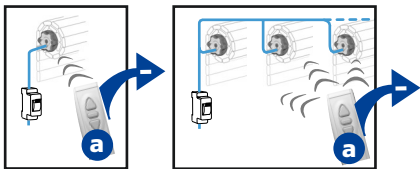

a

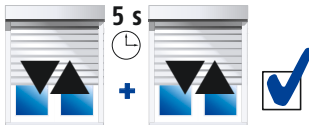
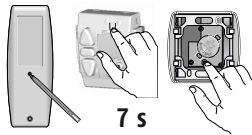

1
2
3
4
5
6
7

- GB** Erase the memory of motor
- I** Cancellare memoria del motore
- N** total radering av motorens minne

- F** Effacement complet de la mémoire moteur
- E** Reset (puesta a cero del operador)
- DK** Total sletning af motorens hukommelse

- NL** Volledig wissen van het motorgeheugen
- P** Apagar a memoria do operador
- SF** Mootorin muistin tyhjennys

- D** Zurücksetzen eines Motors in Auslieferungszustandes
- S** Total radering av motorens minne
- GR** Διαγραφή της μνήμης του μοτέρ

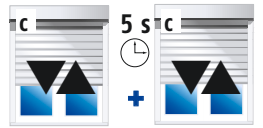
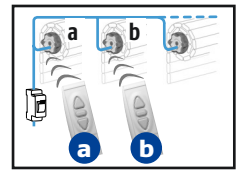
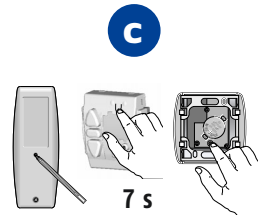
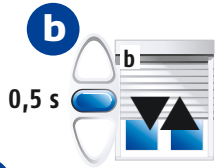
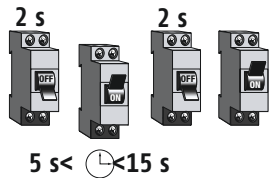
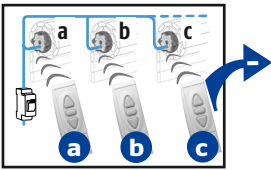

- GB** End limits re-adjustment
- I** Riprogrammazione dei fine corsa
- N** omjustering av endebytere

- F** Réajustement des fins de course
- E** Reajuste de los finales de carrera
- DK** Efterjustering af endestop

- NL** Bijstellen van de eindposities
- P** Reajuste dos fins de curso
- SF** Rajojen uudelleen säätö

- D** Ändern der Endlagen
- S** Omjustering av gränslägen
- GR** Διόρθωση των ορίων

B

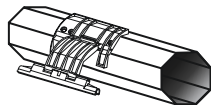

+



D

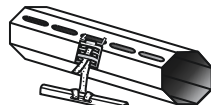

+



- GB** Up limit adjustment
- I** Regolazione del fine corsa alto
- N** Regulering øvre grense
- NL** Afstelling bovenste positie
- P** Regulação do ponto alto
- SF** Ylärajan asetus

- F** Réglage limite haute
- E** Reglaje límite alto
- DK** Indstilling af øverste grænse
- D** Ändern der oberen Endlage
- S** Inställning av övre gränsläge
- GR** Ρύθμιση πάνω όριου



5 s



2 s

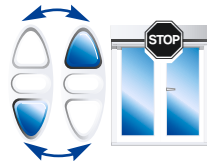

2 s



- GB** End limits re-adjustment
- I** Riprogrammazione dei fine corsa
- N** omjustering av endebytere

- F** Réajustement des fins de course
- E** Reajuste de los finales de carrera
- DK** Efterjustering af endestop

- NL** Bijstellen van de eindposities
- P** Reajuste dos fins de curso
- SF** Rajojen uudelleen säätö

- D** Ändern der Endlagen
- S** Omjustering av gränslägen
- GR** Διόρθωση των ορίων

C

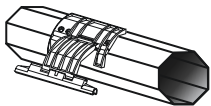

+



D

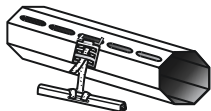

+



- GB** Down limit adjustment
- I** Regolazione del fine corsa basso
- N** Regulering nedre grense
- NL** Afstelling onderste positie
- P** Regulação do ponto baixo
- SF** Alarajan asetus

- F** Réglage limite basse
- E** Regulación del punto bajo
- DK** Indstilling af nederste grænse
- D** Ändern der unteren Endlage
- S** Inställning av nedre gränsläge
- GR** Ρύθμιση κάτω όριου



5 s



2 s

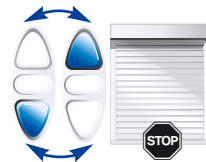

2 s



1

2

3

4

5

6

7

GB Trouble shooting

The motor doesn't work :

Verify :

- the wiring of motor
- the heat generated (wait for the cooling of motor)
- the suitability of the cable used (3wires)
- the battery of the remote control
- the compatibility of remote control
- the control is properly programmed into the memory of the motor
- there is no interference from other radio equipment

The equipment stops too soon :

Verify :

- the crown is properly fitted to the tube (see § 1)
- the end-limits of motor are properly adjusted (see § 1)

F Dépannage

Le moteur ne fonctionne pas :

Vérifier :

- le câblage du moteur
- le contact thermique (attendre le refroidissement du moteur)
- la conformité du câble utilisé (3 conducteurs)
- la pile de la télécommande
- la compatibilité des télécommandes
- la bonne mémorisation de la télécommande par le moteur
- l'absence d'interférences radio

L'appareillage s'arrête trop tôt :

Vérifier :

- que la couronne d'entraînement est bien solidarisée au tube (voir § 1)
- que les fins de course du moteur soient bien réglées (voir § 1)

NL Verhelpen van storingen

De buismotor werkt niet :

Controleer:

- Of er netspanning aanwezig is; of de buismotor correct is aangesloten
- Of de buismotor 'thermisch' is uitgeschakeld (beveiliging). Wacht 10 à 15 minuten tot de buismotor is afgekoeld
- Of het juiste motorsnoer is toegepast; voor een OXIMO RTS motor mag alleen een SOMFY snoer met bruine motorsteker gebruikt worden
- Of de batterij van het bedieningspunt niet leeg is
- Of het juiste draadloze bedieningspunt is toegepast
- Of het bedieningspunt juist is geprogrammeerd
- Of er sprake kan zijn van apparatuur die mogelijke storingen veroorzaken

De buismotor stopt te vroeg.

Controleer:

- Of de eindafstellingen van de buismotor juist zijn afgesteld
- Of de adapter en meenemer goed in de oprolbuis passen
- Of de adapter van de eindafstelling goed meegenomen wordt door de oprolbuis
- Of de inkeping in de oprolbuis voor de nok van de adapter goed past
- Of de meenemer op de as van de buismotor goed in de oprolbuis is gemonteerd

D Abhilfe bei Störungen:

Der Motor reagiert nicht :

Überprüfen Sie:

- den elektrischen Anschluß
- ob der Thermoschutz ausgelöst hat (Abkühlen lassen)
- ob das richtige Anschlußkabel verwendet wurde (RTS Kabel)
- die Batterie des Funksenders
- ob der Sender eingelernt wurde
- ob Funkstörungen auftreten

Der Antrieb stoppt zu früh :

Überprüfen Sie:

- die Einstellung der Endlagen
- ob der Adapter fest mit der Welle verbunden ist

I Risoluzione dei problemi

L'operatore non funziona correttamente :

Verificare :

- Il cablaggio del motore
- la termica (aspettare che il motore si raffreddi)
- la conformità del cavo utilizzato (3 fili)
- la batteria del telecomando
- la compatibilità del telecomando
- la corretta memorizzazione del telecomando nel motore
- l'assenza di interferenze radio

L'apparecchio si ferma prima :

Verificare :

- la corona di trascinamento sia ben adattata al tubo (vedere paragrafo 1)
- i fine corsa del motore siano ben regolati (vedere paragrafo 1)

E Que hacer si:

El operador no funciona cuando se le envía una orden :

Comprobar:

- el cableado del operador
- si está accionada la protección térmica (esperar que el operador recupere su temperatura de funcionamiento)
- el cable utilizado (3 hilos)
- la batería del emisor
- la compatibilidad del emisor
- que el proceso de memorización del emisor ha sido correctamente realizado
- la ausencia de radio interferencias

El sistema se para antes de alcanzar los finales de carrera:

Comprobar:

- la correcta colocación de la corona y que ésta gire a la par con el tubo
- que los finales de carrera han sido correctamente programados (ver capítulo 1)

1

2

3

4

5

6

7

P Guia de diagnóstico:

Operador não funciona quando se envia uma ordem :

Verificar:

- o cabo de alimentação do operador,
- se está accionada a protecção térmica (esperar que o operador recupere a sua temperatura de funcionamento,
- a conformidade do cabo utilizado (3 fios)
- a bateria do emissor
- a compatibilidade do emissor
- que o processo de memorização do emissor tenha sido correctamente realizado
- interferências radio

Sistema pára antes de alcançar os fins de curso :

Verificar:

- a correcta fixação da roda motriz com o tubo de enrolamento (capítulo 1)
- que os fins de curso tenham sido correctamente programados (capítulo 1)

S Felsökning

Motorn fungerar inte :

Kontrollera:

- motorns anslutningar
- att termoskyddet ej löst ut (vänta tills motorn svalnat, ca 10-15 min)
- att rätt anslutningskabel används (3- ledare)
- att sändarens batteri ej är urladdat
- att rätt sändare används
- att sändaren är riktigt inprogrammerad i motorns mottagare
- att det inte finns några radiostörningar

Installationen stannar på fel ställe :

Kontrollera:

- att drivhjulet är korrekt monterat (se punkt 1)
- att motorns gränslägen är korrekt inställda (se punkt 1)

N Feilsøking

Motoren fungerer ikke:

Kontroller:

- motorenes tilkoblinger
- at varmebeskyttelsen ikke har løst ut (vent til motoren er avkjølt, ca 10-15 min)
- at riktig tilkoblingskabel er brukt (3- leder m. 3 x 1,5 mm² tj.)
- at senderens batteri ikke er tomt
- at det brukes riktig sender
- at senderen er riktig programmert i motorenes mottaker
- at det ikke er noen radioforstyrrelser

Installasjonen stopper på feil sted:

Kontroller:

- at drivhjulet er riktig montert (se punkt 1),
- at motorenes endeosisjon er riktig innstilt (se punkt 1)

1

2

3

4

5

6

7

1

DK Fejlfinding**Motoren fungerer ikke :**

Kontrollér:

- motorens tilslutninger
- at motorens sikring ikke er udløst (vent til motoren er kølet ned, ca. 10-15 min.)
- at der anvendes korrekt tilslutningskabel (3-leder)
- at senderens batteri ikke er afladet
- at der anvendes korrekt sender
- at senderen er korrekt indprogrammeret i motorens modtager
- at der ikke er nogen radioforstyrrelser

4

Installationen stopper på et forkert sted :

Kontrollér:

- at drivhjulet er korrekt monteret (se punkt 1)
- at motorens endestop er korrekt indstillet (se punkt 1)

7

SF Vianetsintä**Moottori ei toimi :**

Tarkasta:

- moottorin liitännät
- ettei lämpösuoja ole lauennut (odota, kunnes moottori on jäähtynyt, n. 10-15 min)
- että käytät oikeaa liitäntäkaapelia (kolmijohdinkaapeli)
- ettei lähettimen paristo ole tyhjä
- että käytät oikeaa lähetintä
- että lähetin on ohjelmoitu oikein moottorin vastaanottimeen
- ettei esiinny radiohäiriöitä

Asennus pysähtyy väärään kohtaan :

Tarkasta :

- että vetopyörä on asennettu oikein (katso kohta 1)
- että moottorin raja-asetukset on asetettu oikein (katso kohta 1)

GR Προβλήματα λειτουργίας**Το μοτέρ δεν λειτουργεί :****Ελέγξτε :**













- Την καλωδίωση του μοτέρ
- Το θερμικό διακόπτη (περιμένετε να κρυώσει το μοτέρ)
- Το καλώδιο που χρησιμοποιείτε (3 καλώδια)
- Τη μπαταρία του τηλεχειρισμού
- Τη συμβατότητα του τηλεχειρισμού
- Τη σωστή καταχώρηση του τηλεχειρισμού από το μοτέρ
- Η απουσία πιθανής ράδιο παρεμβολής













Η συσκευή σταματά νωρίς :**Ελέγξτε :**

- Οτι η κορώνα είναι ασφαλισμένη καλά στο σωλήνα (βλέπε παράγραφο 1)
- Οτι έχουν ρυθμιστεί σωστά τα όρια του μοτέρ (βλέπε παράγραφο 1)



A series of horizontal dotted lines spanning the width of the page, providing a guide for handwriting practice.

- GB**  Hereby, SOMFY, declares that this equipment is in compliance with the essential requirements and other relevant provisions of Directive 1999/5/EC.
A Declaration of Conformity is available at the web address www.somfy.com Heading CE Usable in EU, 
- NL**  Hierbij verklaart SOMFY dat dit apparaat in overeenstemming is met de essentiële eisen en andere relevante bepalingen van de Europese richtlijn 1999/5/EC. Een verklaring van overeenstemming is beschikbaar op de website: www.somfy.com onder het hoofdstuk CE. bruikbaar in EU, 
- I**  Noi, SOMFY, dichiariamo che questo prodotto è conforme alle esigenze essenziali, così come alle altre disposizioni pertinenti, previste dalla direttiva 1999/5/EC. Un'apposita dichiarazione di conformità è stata messa a disposizione all'indirizzo internet www.somfy.com Rubrica CE. utilizzabile in EU, 
- P**  A SOMFY declara que este equipamento cumpre os requisitos essenciais e outras normativas relevantes da Directiva 1999/5/EC. Uma Declaração de Conformidade encontra-se disponível na Internet em www.somfy.com Heading CE. Utilizável nos EU, 
- N**  Somfy forsikrer hermed at dette utstyret oppfyller nødvendige krav og andre relevante bestemmelser i direktivet 1999/5/EC. En samsvarserklæring kan hentes på www.somfy.com, rubrikk CE. Kan benyttes innen EU,  N
- SF**  Täten SOMFY ilmoittaa, että tämä laitteisto noudattaa keskeisiä vaatimuksia ja muita oleellisia ehtoja Direktiivistä 1999/5/EC. Julistus sääntöjen mukaisuudesta on saatavana web-osoitteesta www.somfy.com, otsikko CE. Voidaan käyttää EU, 

- F**  Nous SOMFY, déclarons que ce produit est conforme aux exigences essentielles et autres dispositions pertinentes de la directive 1999/5/EC. Une déclaration de conformité est mise à disposition à l'adresse Internet www.somfy.com rubrique CE. Utilisable en UE, 
- D**  CE Hiermit erklärt SOMFY, dass dieses Produkt den wesentlichen Anforderungen und anderen relevanten Vorschriften der Direktive 1999/5/EC entspricht. Die Konformitätserklärung kann abgerufen werden unter der Internet-Adresse www.somfy.com, Klausel verwendbar in EU, 
- E**  Nosotros, Sociedad SOMFY, declaramos que este producto está en conformidad con los requisitos esenciales y otras provisiones relevantes del directivo 1999/5/EC. Una declaración de la conformidad queda a disposición en el Internet a las señas www.somfy.com Rubrique CE utilizable en la UE, 
- S**  SOMFY intygar att denna produkt uppfyller krav och rekommendationer fastställda av direktiv 1999/5/EC. En deklaration om överensstämmelse är tillgänglig på web adressen : www.somfy.com, rubrik CE. Användbar inom EU, 
- DK**  Somfy bekræfter hermed at dette produkt er i overensstemmelse med kravene anført i direktiv nr. 1999/5/EC. En overensstemmelses deklaration er disponibel på adressen www.somfy.com under titlen CE. Anvendelig i EU, 
- GR**  Δια της παρούσης η SOMFY, δηλώνει ότι η παρούσα συσκευή συμμορφώνεται με τις ουσιαστικές απαιτήσεις και τις άλλες σχετικές προβλέψεις της ντιρεκτίβας 1999/5/EC. Η σχετική Δήλωση Συμμόρφωσης είναι διαθέσιμη στο διαδύκτιο με διεύθυνση www.somfy.com Heading CE. Κατάλληλο για την ΕΕ, 



www.somfy.com

Australia : SOMFY PTY LTD
www.somfy.com

Austria : SOMFY GesmbH
www.somfy.at

Belgium : NV SOMFY SA
www.somfy.be

Brasil : SOMFY BRASIL STDA
www.somfy.com

Canada : SOMFY ULC
www.somfy.com

Cyprus : SOMFY MIDDLE EAST
www.somfy.com

Czech Republic : SOMFY Spol s.r.o.
www.somfy.com

Denmark : SOMFY AB DENMARK
www.somfy.dk

Finland : SOMFY AB FINLAND
www.somfy.se

France : SOMFY FRANCE
www.somfy.fr

Germany : SOMFY GmbH
www.somfy.de

Greece : SOMFY HELLAS
www.somfy.com

Hong Kong : SOMFY Co. Ltd
www.somfy.com

Hungary : SOMFY Kft
www.somfy.com

India : SOMFY INDIA PVT Ltd
www.somfy.com

Italy : SOMFY ITALIA S.R.L
www.somfy.it

Japan : SOMFY KK
www.somfy.co.jp

Lebanon : cf. Cyprus - SOMFY MIDDLE EAST
www.somfy.com

Mexico : SOMFY MEXICO SA de CV
www.somfy.com.mx

Morocco : SOMFY MAROC
www.somfy.com

Netherlands : SOMFY BV
www.somfy.nl

Norway : SOMFY NORWAY
www.somfy.se

Poland : SOMFY SP Z.O.O
www.somfy.pl

Portugal : cf. Spain - SOMFY ESPANA SA
www.somfy.com

Russia : cf. Germany - SOMFY GmbH
www.somfy.de

Singapore : SOMFY PTE LTD
www.somfy.com.sg

Slovaquia : cf. Czech Republic - SOMFY Spol s.r.o.
www.somfy.com

South Korea : SOMFY JOO
www.somfy.co.kr
Spain : SOMFY ESPANA SA
www.somfy.com

Sweden : SOMFY AB
www.somfy.se

Switzerland : SOMFY A.G.
www.somfy.ch

Taiwan : SOMFY TAIWAN
www.somfy.com

United Kingdom : SOMFY LTD
www.somfy.co.uk

United States : SOMFY SYSTEMS Inc
www.somfysystems.com