

animeo®

IB+ 1 AC Motor Controller WM/PCB 100-240 V AC

Installation guide
Guida all'installazione
Notice d'installation
Installationsanvisningar

Montagehandleiding
Installasjonsanvisninger
Gebrauchsanweisung
Asennusohjeet

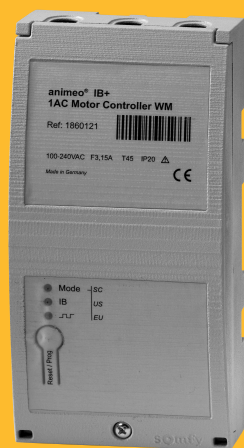

Ref. 1860121



Ref. 1860122

A

[1]



[2]

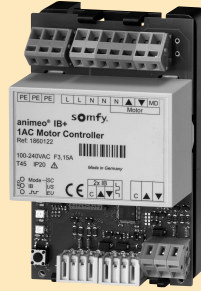

B

[1]

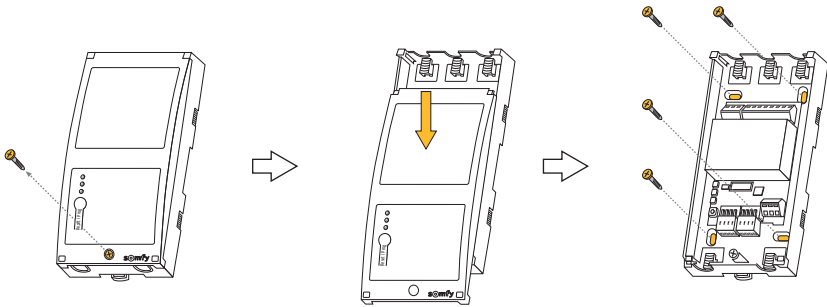

[2]

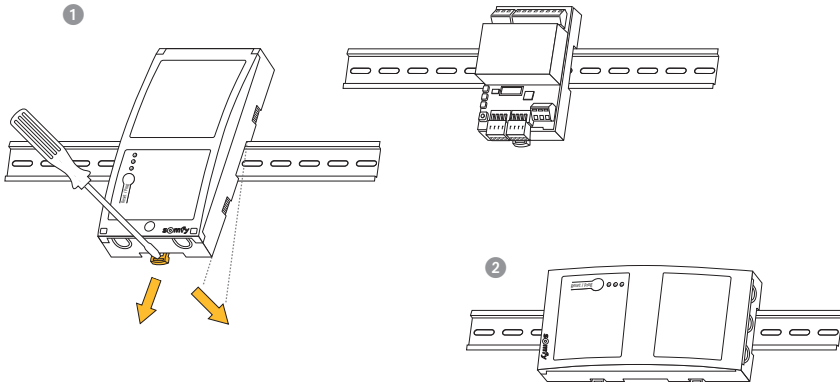

C

[1]

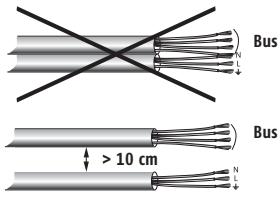

[2]

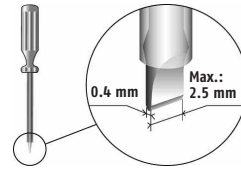

[3]

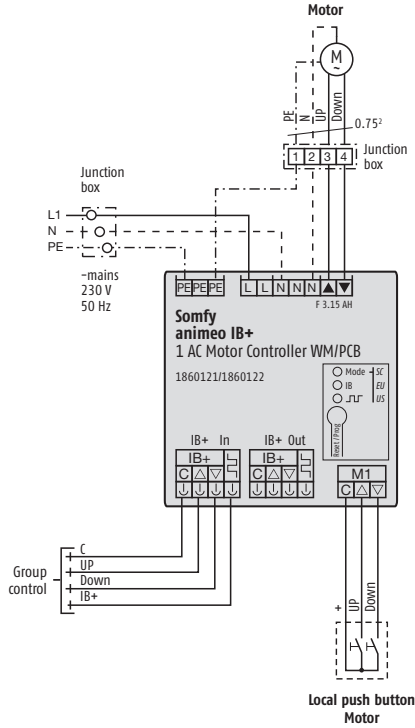

[4]

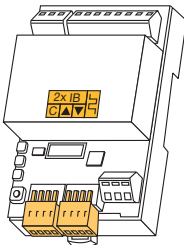

[5]

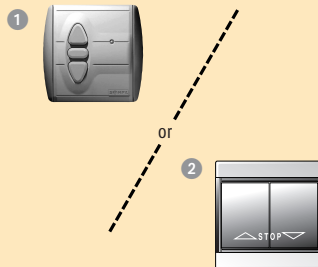

D

[1]

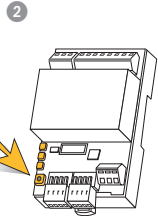
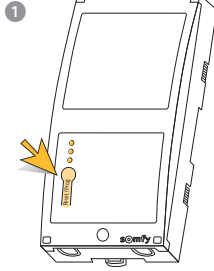
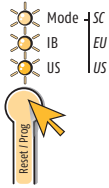

or

[2]

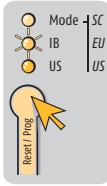

2 s

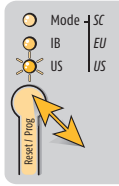
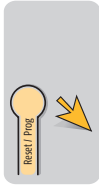

1

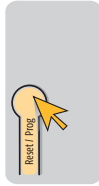
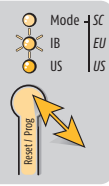
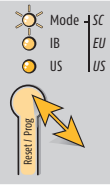

2 s

[3]

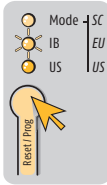

10 s

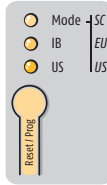
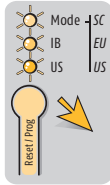

[4]

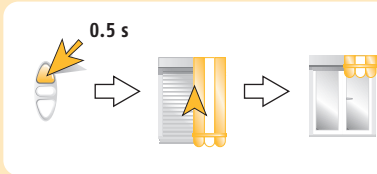

0.5 s

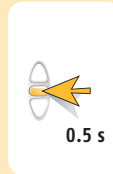

0.5 s

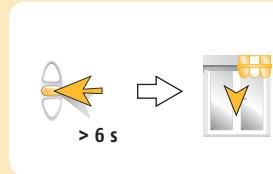

> 6 s

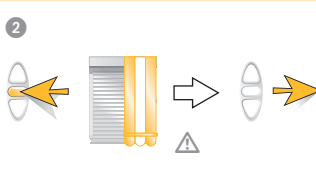
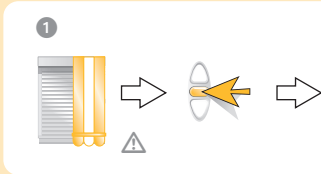

[5]



[6]



A PICTURES

- [1] 1 AC Motor Controller WM 100-240 V AC, wall mounted version
- [2] 1 AC Motor Controller PCB 100-240 V AC, PCB version (with DIN rail clip, Ref. 9000910)

B MOUNTING

Choose the optimal location: flat and large surface, open the housing.

- [1] Mount the 1 AC Motor Controller WM
- [2] Mount the DIN rail version
 1. Vertical (wall mounted or PCB version)
 2. Horizontal (wall mounted version)

C WIRING

- [1] Connect power supply and wiring to the Motor Controller
- [2] Insulated screwdriver
- [3] Wiring diagram
- [4] Check the correct running directions of the end product
UP: the end product goes up (c + ▲)
STOP: the end product stops (c + ▼ + ▲)
DOWN: the end product goes down (c + ▼)
- [5] Possible switches
 1. Inteo Centralis IB, Ref. 1810138
 2. Double push button

D CONFIGURATION

- [1] **Reset / Prog button**
With this button, you can access the basic configuration of the Motor Controller.
 1. Wall mounted version
 2. PCB version
- [2] **Selection of switch ergonomic**
Local push button ergonomics and the type of end products to be preselected:
 - Screen mode
 - Venetian blind, European mode (default mode)
 - Venetian blind, US mode
 1. To toggle between modes, press the Reset / Prog button 2 s. Repeat until the LED, according to the desired configuration, lights up. Store by pressing 2 s.
- [3] **Factory RESET**
- [4] **Learn running and tilting times/length**
 1. Press immediately when lower end limit is reached
 2. Maintain stop for duration of tilting
- [5] **Symbols: actions**
 1. Up
 2. Stop
- [6] **Symbols: end product status**
 1. Up
 2. Upper end position
 3. Down
 4. Lower end position

A DESCRIZIONE DEL PRODOTTO

- [1] 1 AC Motor Controller WM 100-240 V AC, versione montaggio a muro
- [2] 1 AC Motor Controller PCB 100-240 V AC, versione PCB (con supporto guida DIN a clip, Ref. 9000910)

B MONTAGGIO

Scegliere un luogo adatto: superficie liscia con sufficiente spazio.

- [1] Montare il Motor Controller 1 AC WM
- [2] Versione montaggio su guida DIN
 1. Verticale (versione montaggio a muro o PCB)
 2. Orizzontale (versione montaggio a muro)

C COLLEGAMENTO ELETTRICO

- [1] Connettere l'alimentazione e cablare i Motor Controller quindi connettere l'alimentazione agli altri controlli
- [2] Cacciavite isolato
- [3] Schema di cablaggio
- [4] Controllare il corretto senso di movimento del prodotto portante
SALITA: il prodotto portante sale (c + ▲)
STOP: il prodotto portante si arresta (c + ▼ + ▲)
DISCESA: il prodotto portante scende (c + ▼)
- [5] Possibili doppi pulsanti
 1. Inteo Centralis IB, Ref. 1810138
 2. Doppi pulsanti

D CONFIGURAZIONE

- [1] **Pulsante Reset / Prog**
Con questo pulsante è possibile accedere alle configurazioni base del Motor Controller.
 1. Versione montaggio a muro
 2. Versione PCB
- [2] **Selezione della modalità**
La tipologia del pulsante e del prodotto portante deve essere preselezionata:
 - Modalità screen
 - Venetian blind, modalità europea (modalità predefinita)
 - Veneziane, modalità US
 1. Per cambiare la modalità premere il pulsante Reset / Prog per 2 s. Ripetere fino a che il LED si accende sulla configurazione desiderata. Memorizzare premendo per 2 s.
- [3] **Ritorno ai parametri di Default**
- [4] **Acquisizione del tempo di funzionamento e di tilting/corsa**
 1. Premere immediatamente quando viene raggiunto il finecorsa basso
 2. Mantenere premuto STOP per tutta la durata del tilting
- [5] **Simbologia: gli azionamenti**
 1. Salita
 2. Stop
- [6] **Simbologia: stato del prodotto portante**
 1. Salita
 2. Fine corsa alto
 3. Discesa
 4. Fine corsa basso

A IMAGES

- [1] 1 AC Motor Controller WM 100-240 V AC, montage mural
- [2] 1 AC Motor Controller PCB 100-240 V AC, version PCB (avec clip rail DIN, Ref. 9000910)

B INSTALLATION

Choisir le meilleur emplacement: surface plane et spacieuse.

- [1] Fixer le Motor Controller 1 AC WM
- [2] Version rail DIN
 1. Vertical (montage mural ou version PCB)
 2. Horizontale (montage mural)

C CÂBLAGE

- [1] Connecter l'alimentation et les fils électriques au Motor Controller
- [2] Tournevis isolé
- [3] Schéma de câblage
- [4] Contrôle de la direction de fonctionnement des produits porteurs
MONTÉE: le produit porteur monte (\uparrow + \blacktriangle)
ARRÊT: le produit porteur s'arrête (\uparrow + \blacktriangledown + \blacktriangle)
DESCENTE: le produit porteur descend (\uparrow + \blacktriangledown)
- [5] Boutons poussoirs
 1. Inteo Centralis IB, Ref. 1810138
 2. Bouton double

D CONFIGURATION

- [1] **Reset / Prog bouton**
Ce bouton permet d'accéder à la configuration basique de l'automatisme.
 1. Montage mural
 2. Version PCB
- [2] **Sélection de l'ergonomie des boutons poussoirs**
Ergonomie des boutons poussoirs et type de produits porteurs à sélectionner:
 - Mode screen (store rouleaux)
 - Store vénitien et mode "Europe" (mode par défaut)
 - Store vénitien et mode "US"
 1. Pour changer de modes, pressé le bouton Reset / Prog pendant 2 s. Répéter jusqu'à avoir la LED qui s'allume dans la configuration désirée. Enregistrement en appuyant 2 s.
- [3] **Retour configuration usine**
- [4] **Acquisition du temps de fonctionnement et de rotation/course**
 1. Appuyer immédiatement quand la butée basse est atteinte
 2. Maintenir stop appuyé pendant toute la durée de rotation
- [5] Symboles: les actions
 1. Montée
 2. Arrêt
- [6] Symboles: état du produit porteur
 1. Montée
 2. Position haute
 3. Descente
 4. Position basse

CABLE CAVO CÂBLAGE

Connection to... Connettere a... Connexion aux...	Cables Cavo Câble	Twisted pairs Doppino Paires torsadées	Max. distance Max. distanza Longueur maximum
Motors	Min.: 4 x 0.75 mm ² /16 AWG Max.: 4 x 2.5 mm ² /13 AWG	-	150 m
Switches	Min.: 3 x 0.6 mm ² /19 AWG Max.: 3 x 2.5 mm ² /13 AWG	Recommended	150 m
Group control	Min.: 3 x 0.6 mm ² /19 AWG Max.: 3 x 1.5 mm ² /13 AWG	Recommended	1 000 m
100-230 V AC	Min.: 3 x 0.75 mm ² /16 AWG Max.: 3 x 2.5 mm ² /13 AWG		

SE

A BILDER

- [1] 1 AC Motor Controller WM 100–240 V AC, väggmonterad version
- [2] 1 AC Motor Controller PCB 100–240 V AC, PCB version (med DIN-clips, Ref. 9000910)

B INSTALLATION

Välj rätt placering: plan yta med tillräcklig plats.

- [1] Montera Motorkontrollen 1 AC WM
- [2] DIN monterad version
 1. Vertikal (väggmonterad eller PCB version)
 2. Horisontell (väggmonterad version)

C KABLAGE

- [1] Anslut matnings- och övriga kablar till Motorkontrollen
- [2] Isolerad skruvmejsel
- [3] Kabeldiagram
- [4] Kontrollera korrekt gångriktning av slutprodukterna
UPP: Slutprodukten går upp (◀ + ▲)
STOPP: Slutprodukten stannar (◀ + ▼ + ▲)
NER: Slutprodukten går ner (◀ + ▼)
[5] Möjliga brytare
 1. Inteo Centralis IB, Ref. 1810138
 2. Dubbel standardsbrytare

D KONFIGURERING

- [1] **Reset / Prog-knapp**
Med denna knapp kan du komma åt grundläggande funktioner i motorstyrenheten.
 1. Väggmonterad version
 2. PCB version
- [2] **Val av knappergonomi**
Val av den lokala knappergonomi och typen av slutprodukt:
 - Screnergonomi
 - Persienn med EU-ergonomi (standard ergonomi)
 - Persienn med US-ergonomi
 1. För att växla mellan olika lägen, tryck Reset / Prog-knappen 2 s. Upprepa tills rätt LED lyser. Lagra genom att trycka 2 s.
- [3] **Fabriksinställningar**
- [4] **Programmera kör- och vinklingstider**
 1. Tryck omgående när nedre gränsläget är nått
 2. Håll stopp intryckt under hela vinklingstiden
- [5] **Symboler: manövrering**
 1. Upp
 2. Stopp
- [6] **Symboler: solskyddets status**
 1. Upp
 2. Helt uppkört
 3. Ned
 4. Helt nedkört

NL

A AFBEELDING

- [1] 1 AC Motor Controller WM 100–240 V AC, opbouw versie
- [2] 1 AC Motor Controller PCB 100–240 V AC, DIN rail versie (met clip, Ref. 9000910)

B MONTAGE

Kies de juiste plaats: vlakke ondergrond met voldoende ruimte.

- [1] Monteer de Motor Controller 1 AC WM
- [2] DIN rail montage
 1. Vertikaal (opbouw of DIN rail versie)
 2. Horizontaal (opbouw versie)

C BEDRADING

- [1] Sluit de bedrading en de netspanning aan naar de Motor Controller
- [2] Geïsoleerde schroevendraaier
- [3] Aansluitschema
- [4] Controleer de juiste looprichting van het eindproduct
OP: het eindproduct gaat omhoog (◀ + ▲)
STOP: het eindproduct stopt (◀ + ▼ + ▲)
NEER: het eindproduct gaat omlaag (◀ + ▼)
- [5] Mogelijke schakelaars
 1. Inteo Centralis IB, Ref. 1810138
 2. Schakelaars

D CONFIGURATIE

- [1] **Reset / Prog knop**
Met deze knop krijgt u toegang tot de standaard configuratie van de Motor Controller.
 1. Opbouw versie
 2. DIN rail versie
- [2] **Keuze van de schakelaar functie**
Functie keuze van de ind. bed. schakelaar en keuze van de eindproducten:
 - Zonwering functie
 - Jaloezie, EU functie (standaard configuratie)
 - Jaloezie, US functie
 1. Om te schakelen tussen de functies, druk 2 s op de Reset / Prog toets. Herhaal dit tot de gewenste LED gaat branden. Opslaan door 2 s te drukken.
- [3] **Terug naar fabrieksstand**
- [4] **Looptijd en kanteltijd leren/length**
 1. Druk onmiddellijk als de onderste positie bereikt is
 2. Stop vasthouden tijdens het kantelen
- [5] **Symbolen: acties**
 1. Op
 2. Stop
- [6] **Symbolen: status van het eindproduct**
 1. Op
 2. Bovenste positie
 3. Neer
 4. Onderste positie

NO

A BILDER

- [1] 1 AC Motor Controller WM 100-240 V AC, veggmontert versjon
- [2] 1 AC Motor Controller PCB 100-240 V AC, PCB versjon (med DIN rail feste, Ref. 9000910)

B MONTERING

Velg riktig plassering: plan overflate med god plass.

- [1] Monter motorkontrollen (Motor Controller) 1 AC WM
- [2] DIN montert versjon
 - 1. Vertikal (veggmontert eller PCB versjon)
 - 2. Horisontal (veggmontert versjon)

C KABLING

- [1] Tilkoble strøm og øvrige kabler til øvrige kontrollere
- [2] Isolert skrutrekker
- [3] Kabel skjema
- [4] Sjekk riktig dreieretning på sluttproduktet
 - OPP: sluttproduktet skal gå opp (c + ▲)
 - STOPP: sluttproduktet skal stoppe (c + ▼ + ▲)
 - NED: sluttproduktet skal gå ned (c + ▼)
- [5] Mulige brytere
 - 1. Inteo Centralis IB, Ref. 1810138
 - 2. Dobbel std. bryter

D KONFIGURERING

- [1] **Reset / Prog knapp**

Med denne knappen kan du aktivere basis konfigurasjon av motorkontrolleren.

 - 1. Veggmontert versjon
 - 2. PCB versjon
- [2] **Valg av knapp funksjon**

Valg av den lokale knapp funksjonen og type sluttprodukt:

 - Screen funksjon
 - Persienne med EU funksjon (standard funksjon)
 - Persienne med US funksjon

1. For å veksle mellom mode, trykk Reset / Prog knappen i 2 s. Gjenta til LED veksler til ønsket configuration. Lagre ved å trykke 2 s.
- [3] **Fabrikkinstillinger**
- [4] **Program`ere kjøre og vinklingstider**
 - 1. Trykk omgående når nedre endeposisjon er nådd
 - 2. Hold stopp inne under hele vinklingstiden
- [5] **Symboler: manøvrering**
 - 1. Opp
 - 2. Stopp
- [6] **Symboler: status sluttprodukt**
 - 1. Opp
 - 2. Kjørt helt inn
 - 3. Ned
 - 4. Kjørt helt ut

KABLAGE BEDRADING KABLING

Anslutning till... Aansluiting naar... Tilkobling til...	Kabel Bekabeling Kabel	Partvinnad kabel Twisted pair Tvinnet par	Max. avstånd Max. lengte Max. avstand
Motors	Min.: 4 x 0.75 mm ² /16 AWG Max.: 4 x 2.5 mm ² /13 AWG	-	150 m
Switches	Min.: 3 x 0.6 mm ² /19 AWG Max.: 3 x 2.5 mm ² /13 AWG	Recommended	150 m
Group control	Min.: 3 x 0.6 mm ² /19 AWG Max.: 3 x 1.5 mm ² /13 AWG	Recommended	1 000 m
100-230 V AC	Min.: 3 x 0.75 mm ² /16 AWG Max.: 3 x 2.5 mm ² /13 AWG		

DE

A PRODUKTANSICHT

- [1] 1 AC Motor Controller WM 100–240 V AC, Aufputz-Version
- [2] 1 AC Motor Controller PCB 100–240 V AC, Platinen-Version (mit Hutschienenadapter, Ref. 9000910)

B MONTAGE

Wahl des richtigen Montageorts: flache Oberfläche mit ausreichendem Platz bzw. Schaltschrank.

- [1] Montage des Motor Controller 1 AC WM
- [2] Montage auf Hutschiene
 1. Senkrecht (Aufputz- bzw. Platinen-Version)
 2. Waagrecht (Aufputz-Version)

C VERDRÄHTUNG

- [1] Spannungsversorgung anschließen und fertig verdrahten
- [2] Isolierter Schraubendreher
- [3] Anschlussplan
- [4] Prüfen Sie die korrekte Laufrichtung des Endprodukts
AUF: Das Endprodukt bewegt sich aufwärts (c + ▲)
STOPP: Das Endprodukt stoppt (c + ▼ + ▲)
AB: Das Endprodukt bewegt sich abwärts (c + ▼)
 - [5] Mögliche Taster
 1. Inteo Centralis IB, Ref. 1810138
 2. Doppeltaster

D KONFIGURATION

- [1] **Reset / Prog Taste**
Mit dieser Taste können Sie die Konfiguration des Geräts ändern.
 1. Aufputz-Version
 2. Platinen-Version (PCB)
- [2] **Auswahl der Taster Ergonomie**
Auswahl der lokalen Taster Ergonomien und der Art des Endprodukts:
 - Screen Ergonomie
 - Jalousie mit EU Ergonomie (Auslieferungszustand)
 - Jalousie mit US Ergonomie
 1. Zum Umschalten der verschiedenen Ergonomien 2 s die Reset / Prog Taste drücken und anschließend loslassen. Mehrfach kurz drücken bis die gewünschte LED leuchtet. Zum Speichern erneut 2 s drücken.
- [3] **Komplett-RESET**
- [4] **Lauf- und Wendezeit/Länge einlernen**
 1. Sofort drücken, wenn untere Endlage erreicht ist
 2. Stopp halten während der kompletten Wendung
- [5] Symbole: Bedienung
 1. Auf
 2. Stopp
- [6] Symbole: Behangzustand
 1. Auf
 2. Obere Endposition
 3. Ab
 4. Untere Endposition

FI

A KUVAT

- [1] 1 AC Motor Controller WM 100–240 V AC, seinään asennettava malli
- [2] 1 AC Motor Controller PCB 100–240 V AC, PCB versio (DIN kiskoon kiinnikkeillä, Ref. 9000910)

B ASENNUS

Valitse oikea paikka: riittävästi tilaa ja tasainen pinta.

- [1] Asenna moottoriyksikkö (Motor Controller) 1 AC WM
- [2] DIN kiskoon asennettava malli
 1. Vaakamalli (seinään asennettava tai PCB versio)
 2. Pystymalli (seinään asennettava)

C KAAPELOINNIT

- [1] Kytke virtälähde ja johdotukset
- [2] Eristetty ruuvitaltan terä
- [3] Kytkentäkaavio
- [4] Tarkista lopputuotteen oikeat pyörimissuunnat
YLÖS: tuotteen tulee mennä ylös (c + ▲)
SEIS: tuotteen tulee pysähtyä (c + ▼ + ▲)
ALAS: tuotteen tulee mennä alas (c + ▼)
- [5] Mahdolliset kytkimet
 1. Inteo Centralis IB, Ref. 1810138
 2. Kytkimet

D ASETUKSET

- [1] **Reset / Prog painike**
Tällä painikkeella pääset moottoriyksikön perusasetuksiin.
 1. Seinään asennettava malli
 2. PCB versio
- [2] **Ergonomian vaihdon valinnat**
Paikallisen kytkimen ergonomia ja lopputuotteen esivalinta:
 - Screeni tila
 - Sälekäihdin, EU tila (perustila)
 - Sälekäihdin, US tila
 1. Tilan vaihto, paina Reset / Prog painiketta 2 s. Toista, kunnes halutun tilan LED valo syttyy. Tallenna painamalla 2 s.
- [3] **Tehdas PALAUTUS**
- [4] **Opetä ajo- ja kääntöaika/pituus**
 1. Paina välittömästi kunnes alaraja on saavutettu
 2. Pidä seis painettuna koko käännön ajan
- [5] **Symbolit: toiminnan säätö**
 1. Ylös
 2. Seis
- [6] **Symbolit: aurinkosuojan tila**
 1. Ylös
 2. Aivan yläasennossa
 3. Alas
 4. Aivan ala-asennossa

GB Before installation, please read and follow these instructions. An incorrect installation could lead to serious injury. The product must be installed by a qualified electrician. SOMFY's liability for defects and damages is excluded if they were caused by disregard of the instructions. Keep these instructions for future reference.

IT Prima dell'installazione leggere attentamente queste istruzioni. Un'installazione non corretta può causare gravi ferite. L'installazione deve essere eseguita da un elettricista qualificato. SOMFY non può essere ritenuta responsabile per difetti o danneggiamenti causati dal mancato rispetto di queste istruzioni. Conservare queste istruzioni.

FR Avant la mise en œuvre, veuillez lire et suivre les instructions de sécurité ci-jointes. Une mauvaise installation peut conduire à de graves blessures. Le produit doit être installé par un électricien qualifié. SOMFY ne peut être tenue responsable des vices et des dommages occasionnés par un non respect de ces instructions. Conservez ces instructions pour toute intervention sur le produit.

SE Före installation, läs noggrant igenom denna manual och följ sedan instruktionerna. En felaktig installation kan medföra livsfara. Produkten skall installeras av behörig elektriker. SOMFY's åtaganden gäller ej om installation inte utförts enligt instruktionerna. Spara manualen för framtida bruk.

NL Lees voor het installeren eerst deze handleiding. Een onjuiste installatie kan de apparatuur ernstig beschadigen. Dit product mag alleen door een deskundige aangesloten worden. De SOMFY garantie is niet van toepassing als de aanwijzingen in deze handleiding genegeerd worden. Bewaar dit document voor later gebruik.

NO Før installasjon, les disse instruksjer. Feil installasjon kan føre til alvorlig skade. Installasjonen skal utføres av autorisert installatør. SOMFY's ansvar for skader bortfaller hvis disse instruksjoner ikke følges. Behold instruksjonene for fremtidige referanser.

DE Vor Inbetriebnahme unbedingt die Sicherheitsanweisungen in dieser Anleitung beachten. Die Haftung von SOMFY für Mängel und Schäden ist ausgeschlossen, wenn diese auf Nichtbeachten der Gebrauchsanweisung (falsche Installation, Fehlbienung, etc.) beruhen. Errichten, Prüfen und Inbetriebsetzen der Anlage darf nur von einer Fachkraft (lt. VDE 0100) durchgeführt werden! Schalten Sie alle zu montierenden Anschlussleitungen spannungslos! Treffen Sie Vorkehrungen gegen unbeabsichtigtes Einschalten!

FI Ennen asennusta, ole hyvä ja lue ja seuraa näitä ohjeita. Virheellinen asennus voi aiheuttaa vakavia vaurioita. Tuotteen tuulee asentaa valtuutettu sähköasentaja. SOMFY:n vastuu virheistä ja vaurioista poistuu, jos ne ovat aiheutuneet ohjeiden vastaisesta toiminnasta. Säilytä nämä ohjeet.

CHARACTERISTICS: animeo IB+ 1 AC MOTOR CONTROLLER

1 AC Motor Controller	WM Ref. 1860121	PCB Ref. 1860122
Supply voltage	100–240 V AC / 50/60 Hz	100–240 V AC / 50/60 Hz
Stand-by current (primary)	0.3 mA (230 V)	0.3 mA (230 V)
Max. motor current consumption	3.15 A, $\cos \varphi = 0.95$	3.15 A, $\cos \varphi = 0.95$
Supply voltage of group control input	SELV, 16 V DC =	SELV, 16 V DC =
Supply voltage of local push buttons	SELV, 16 V DC =	SELV, 16 V DC =
Terminals	Spring connectors	Spring connectors
Running time per output (relay contact)	Max. 5 minutes	Max. 5 minutes
Fuse per output	3.15 AH	3.15 AH
Operating temperature	0 °C to 45 °C	0 °C to 45 °C
Relative humidity	85 %	85 %
Material of housing	CC-ABS polycarbonate	CC-ABS polycarbonate
Housing dimensions (w x h x d)	90 x 180 x 45 mm	65 x 105 x 20 mm
Degree of protection	IP 20	IP 00
Protection class	II, corresponding to the installation	II, corresponding to the installation
Conformity	CE by EN 60730-1	CE by EN 60730-1

The Motor Controller is an electronic operated, independently mounted control.

Looped-through PE-connection
Type 1 action

Pollution degree: 2

Rated impulse voltage: 4 kV

Temperature of the ball hardness test: 75 °C

Der Motor Controller ist ein elektronisch betätigtes, unabhängig montiertes Regel- und Steuergerät.

Durchgeschleifter Schutzleiteranschluss

Wirkungsweise Typ: 1

Verschmutzungsgrad: 2

Bemessungs-Stoßspannung: 4 kV

Temperatur der Kugeldruckprüfung: 75 °C

AUSTRIA
SOMFY GesmbH
www.somfy.at
Tel.: (43) 662 62 53 08

AUSTRALIA
SOMFY Pty Limited
www.somfy.com.au
Tel.: (61) 2 9638 0744

BELGIUM
SOMFY NV SA
www.somfy.be
Tel.: (32) 2 712 07 70

BRASIL
SOMFY BRASIL Ltda
www.somfy.com.br
Tel.: (55-11) 6161 6613

CANADA
SOMFY ULC
www.somfy.com
Tel.: (1) 905 564 6445

PR CHINA
SOMFY China Co Ltd.
www.somfy.com.ch
Tel.: (86-21) 6280 9660

CHINA
SOMFY Shanghai
www.somfy.com
Tel.: (86) 21 6280 9660

CYPRUS
SOMFY Middle East Co. Ltd.
www.somfy.com
Tel.: (357) 25 34 55 40

CZECH REPUBLIC
SOMFY Spol s.r.o
www.somfy.cz
Tel.: (420) 296 37 24 86-7

DENMARK
SOMFY AB
www.somfy.dk
Tel.: (45) 65 32 57 93

FINLAND
SOMFY Nordic AB
www.somfy.fi
Tel.: (358) 9 57 130 230

FRANCE
SOMFY France
www.somfy.fr
Tel.: (33) 4 50 96 70 96

GERMANY
SOMFY GmbH
www.somfy.de
Tel.: (49) 74 72 93 00

GREECE
SOMFY Hellas SA
www.somfy.com
Tel.: (30) 210 614 67 68

HONG KONG
SOMFY Co. Ltd.
www.somfy.com
Tel.: (852) 2523 63 39

HUNGARY
SOMFY Kft
www.somfy.hu
Tel.: (36) 1814 5120

INDIA
SOMFY India Private Limited
www.somfy.co.in
Tel.: (91) 11 51659176

ISRAEL
SISA HOME AUTOMATION LTD
www.somfy.com
Tel.: (972) 952 55 54

ITALY
SOMFY Italia S.R.L
www.somfy.it
Tel.: (39) 02 48 47 181

JAPAN
SOMFY K.K
www.somfy.co.jp
Tel.: (81) 45 475 07 32

KOREA
SOMFY JOO
www.somfy.co.kr
Tel.: (82) 2 594 4331

KUWAIT
SOMFY Kuwait
www.somfy.com
Tel.: (965) 53 39 592

LEBANON
SOMFY Lebanon
www.somfy.com
Tel.: (961) 1 391 224

MEXICO
SOMFY MEXICO SA de CD
www.somfy.com.mx
Tel.: (11) 525 576 3421

NETHERLANDS
SOMFY Nederland B.V
www.somfy.nl
Tel.: (31) 23 55 44 900

NORWAY
SOMFY Nordic AB
www.somfy.no
Tel.: (47) 67 97 85 05

POLAND
SOMFY SP Z.O.O
www.somfy.pl
Tel.: (48) 22 818 02 97
(48) 22 618 80 56

PORTUGAL
SOMFY Portugal
www.somfy.com
Tel.: (351) 229 396 840

RUSSIA
SOMFY LLC
www.somfy.com
Tel.: (7) 095 3 60 41 86

SINGAPORE
SOMFY PTE LTD
www.somfy.com.sg
Tel.: (65) 638 33 855

SPAIN
SOMFY Espana SA
www.somfy.com
Tel.: (34) 93 480 09 00

SWEDEN
SOMFY Nordic AB
www.somfy.se
Tel.: (46) 40 165 900

SWITZERLAND
SOMFY AG
www.somfy.ch
Tel.: (41) 18 38 40 30

TAIWAN
**SOMFY Development
Taiwan Branch**
www.somfy.com.tw
Tel.: (8862) 8509 8934

UNITED KINGDOM
SOMFY Ltd.
www.somfy.co.uk
Tel.: (44) 113 391 3030

USA
SOMFY Systems Inc.
www.somfysystems.com
Tel.: (1) 609 395 1300