

# animeo® KNX/EIB 4 AC Motor Controller WM/DRM 220-240V AC Installation manual

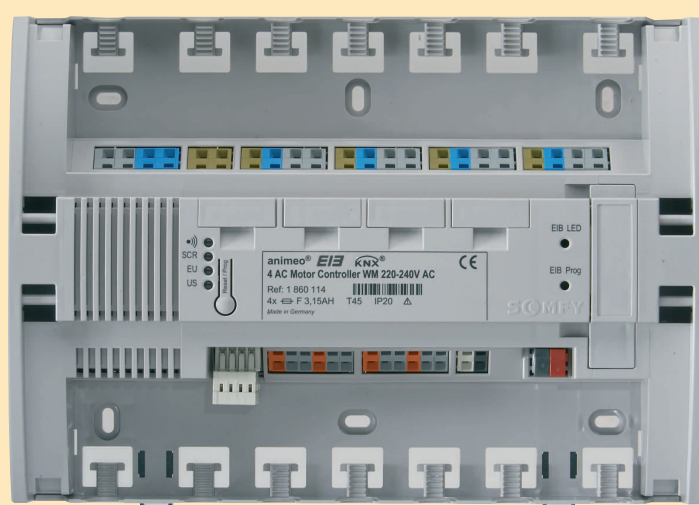

Ref. 1860114

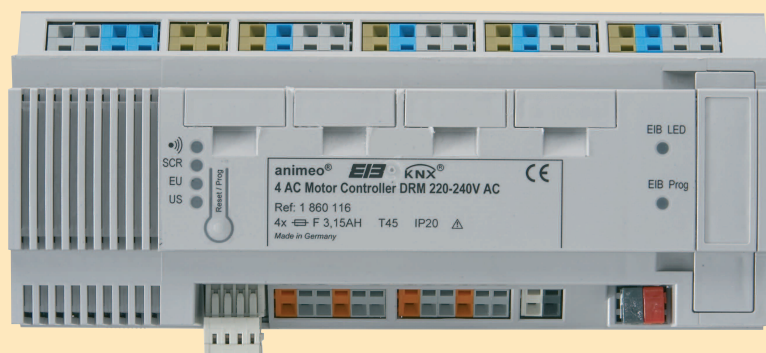

Ref. 1860116

## Table of contents

Introduction .....	3
<b>0</b> Definitions .....	4
<b>1</b> Assembly .....	5
<b>2</b> Wiring Diagram .....	5
2.1 Checking of running direction of the end products .....	6
<b>3</b> Settings on delivery status .....	7
3.1 Function of the Reset/Prog button .....	7
3.2 Selection of different user ergonomics .....	7
3.3 Manual setting of running and tilting times .....	8
3.4 Manual setting of intermediate position 1 .....	8
3.5 Reset to delivery status .....	8
<b>4</b> Communication objects .....	9
<b>5</b> Parameters .....	13
<b>6</b> Diagnosis .....	29
6.1 LEDs on the animeo KNX/EIB Motor Controller .....	29
6.2 Informationen during operation .....	29
6.3 Status of configuration .....	29
<b>7</b> Technical Data .....	30



Before installation, please read the safety instructions carefully. Failure to respect these instructions automatically invalidates warranty and all liability claims against SOMFY (e.g. wrong installation, maloperation etc.). The product must be installed by a qualified electrician! All connections has to be disconnected from mains before mounting! Make precautions against switching on by accident!

The installation of Somfy products has to be made at easily accessible places only. For maintenance and repairs which are difficult to perform because of bad accessibility (e.g. clotted or extensive clotted floors, installation behind lamps or behind façades) additional costs cannot be claimed against the seller.

## Introduction

The animeo EIB/KNX 4 AC Motor Controller WM/DRM 220–240 V AC is designed to control four individual configurable motor outputs for venetian blinds, roller shutters, awnings or windows. Local push button inputs can be used for conventional push buttons or as universal binary EIB inputs. The four outputs can also be controlled individually using the animeo RTS radio module.

### Benefits and product features

- Practical installation benefits which reduce the installation time, e.g. spring connectors, cable tension release, sufficient space for connections,...
- A group input can be used to control all four outputs independent of the ETS programming.
- Single fuse (3.15 AH) protection per motor output.
- Checking of running direction of the end products possible without the ETS.
- The device can be used basically without the need to be programmed by the ETS software.
- The 4 local push button inputs can be used as maximal 8 universal EIB binary inputs to connect for example window contacts, temperature sensors or presence detectors. A conventional push button can also be used to realize dimming functions in combination with lighting actuators.
- User-friendly and intuitive configuration inside the ETS parameter settings.
- Intelligent switching between manual and automatic functions to provide excellent user comfort and powerful energy saving functions.
- Position feedback of each motor output during move and when reaching the UP and DOWN end limits.
- Two free configurable security levels per motor output.
- Free configurable action at mains return and feedback of status via object.
- Automatic cascading of the motor outputs to limit the peak current in case of mains power return and bus safety functions.
- Plug and play! Upgrade with the animeo RTS radio module possible at any time. The four outputs can then easily be controlled via radio remote without additional wiring.
- In cases where radio technology is not permitted, e.g. in hospitals, the motor outputs can also be upgraded and controlled with the animeo infrared module.

## 0 Definitions

All indications in the manual marked with \* refers to the following terms:

- Manual order** A manual order is a command generated by a local conventional switch or by a Somfy RTS radio hand transmitter. A telegram received on the objects 0–7 is also understood as manual command.
- Automatic order** A telegram received on the objects 8–15 is understood as an automatic order.
- US switch ergonomics** With this parameter it is specified that the venetian blind is headed in US ergonomics over the local switch inputs or over Somfy RTS radio hand transmitter.  
Short manipulation of the switch (< 0.5 s): A move command is executed.  
Long manipulation of the switch (> 0.5 s): A tilting command is executed as long as the switch is pressed. When releasing the switch the tilting command is stopped. If the current position of the venetian blind is outside the tilting time, a driving command is implemented with pressed button.
- EU switch ergonomics** With this parameter it is specified that the venetian blind is headed in European Union ergonomics over the local switch inputs or over Somfy RTS radio hand transmitter.  
Short manipulation of the switch (< 0.5 s): A tilting step is implemented.  
Long manipulation of the switch (> 0.5 s): A tilting command is implemented as long as the switch is pressed. If the current position of the venetian blind is outside the tilting time, a driving command is executed.
- Screen switch ergonomics** With this parameter it is specified that the end product is headed for screen ergonomics over the local switch inputs or over Somfy RTS radio hand transmitter.  
Short manipulation of the switch when the end product is in full swing: A stop command is executed.  
Long manipulation when the end product is not in full swing: A driving command is executed.

△ This ergonomic is used to control screens, roller blinds, awnings and windows.

### Slat position

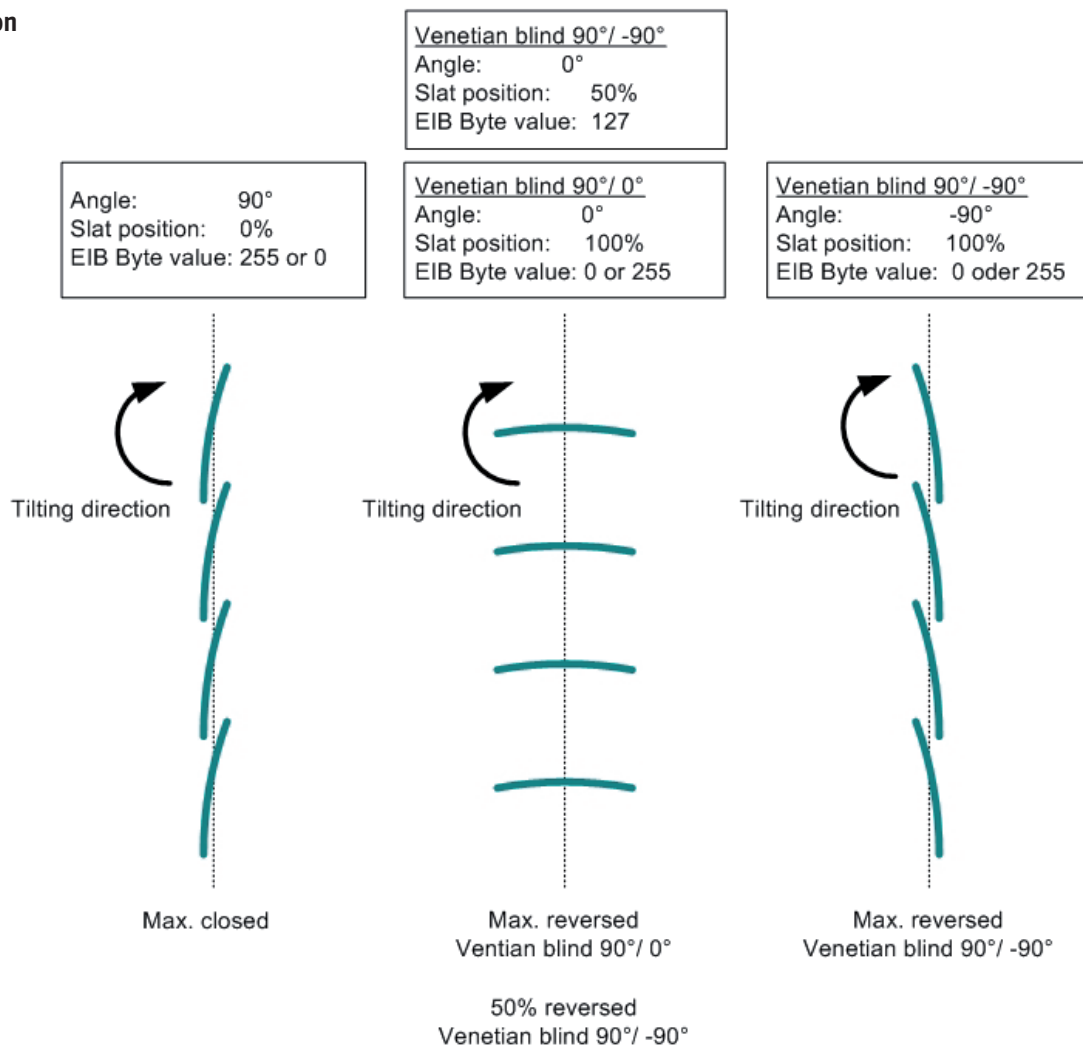

# 1 Assembly

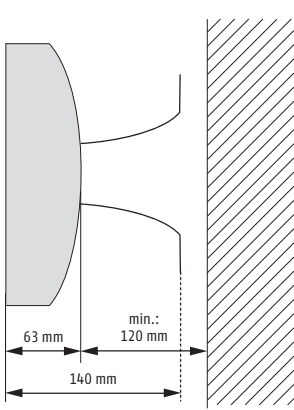

Choose the optimal location:  
flat and large surface

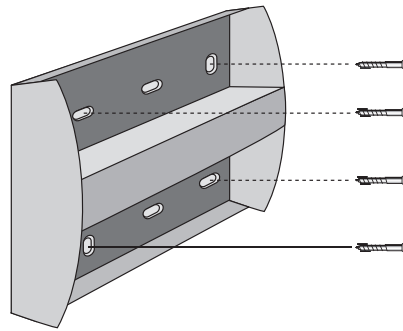

Mount the Motor Controller 4 AC WM

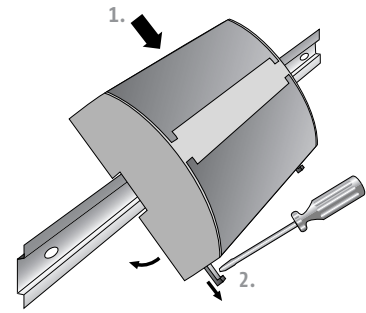

DIN Rail mounted version  
4 AC DRM

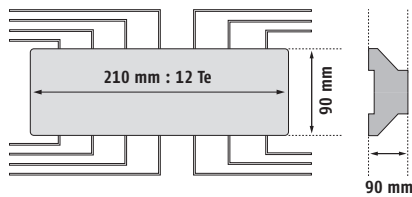

Electrical cabinet

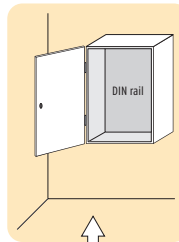

⚠ Check distance when using the animeo RTS radio module!

Connect power supply and wiring to the Motor Controller

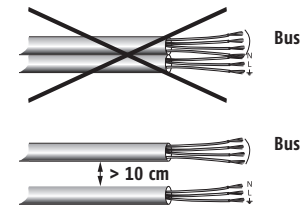

# 2 Wiring diagram

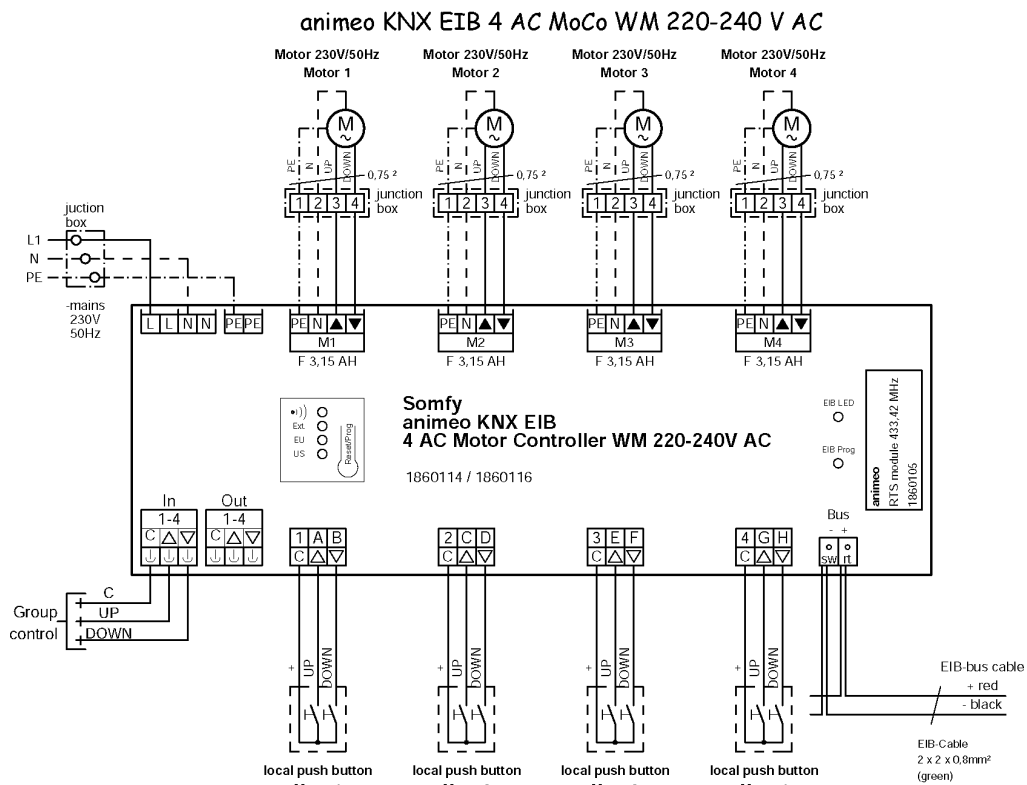

Local push button inputs can be used as universal EIB binary inputs!



⚠ As soon as 230 V and the EIB bus voltage supply are attached the „US“ LED will blink regularly. The device is operational when the „US“ LED is blinking continuously.

#### CABLE

Connections to ...	Cables	Twisted pairs	Max. distance
<b>Motors</b>	Min.: 4 x 0.75 mm <sup>2</sup> /16 AWG Max.: 4 x 2.5 mm <sup>2</sup> /13 AWG	-	150 m
<b>Switches</b>	Min.: 3 x 0.6 mm <sup>2</sup> /19 AWG Max.: 3 x 2.5 mm <sup>2</sup> /13 AWG	Recommended	150 m
<b>Group control</b>	Min.: 3 x 0.6 mm <sup>2</sup> /19 AWG Max.: 3 x 1.5 mm <sup>2</sup> /13 AWG	Recommended	1000 m
<b>EIB bus</b>	2 x 2 x 0.8 mm <sup>2</sup>	Required, following KNX/EIB topology guidelines	
<b>230 V AC</b>	Min.: 3 x 0.75 mm <sup>2</sup> /16 AWG Max.: 3 x 2.5 mm <sup>2</sup> /13 AWG		

## 2.1 Checking of running direction of the blinds

### Group control of the motors 1 - 4 over the group control input

Over the group control input the running directions of the connected motors can be tested. All four motor outputs are switched together. This input can become disabled in the ETS parameters. In the case of a bus voltage failure it is always enabled in order to make an emergency operation possible.

⚠ Absolute guarantee with start-up that the motors run into the correct direction. By cable links and the group control input this test can be accomplished.

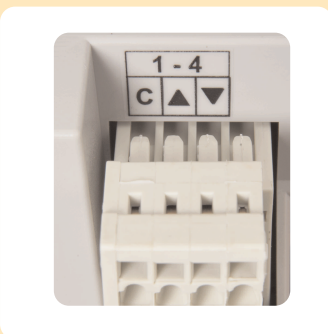

Check the correct direction of the end product

DOWN: The end product heads in the down direction (cable link between C + ▼)

STOP: The end product stops (Cable link between C + ▼ + ▲)

UP: The end product heads in the up direction (cable link between C + ▲)

### 3 Settings on delivery status

The Moco KNX/EIB can be used on delivery without being programmed by the ETS software. Meaningful default values are implemented in the device. These settings apply to all four motor outputs.

- Running times UP/DOWN, CLOSE/OPEN = 5 minutes
- Connection of local conventional switch possible

The local switch inputs are linked 1 to 1 to the motor outputs (fig. 1): switch input 1 controls motor output 1. The motor outputs can be controlled by cable links at the switch inputs as required (fig. 2).

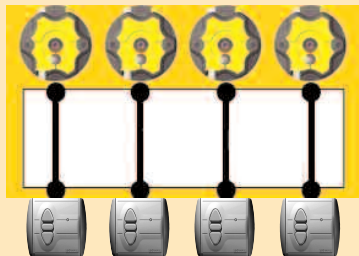

Fig. 1

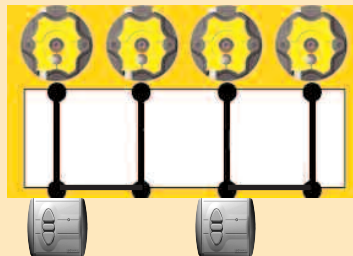

Fig. 2

#### 3.1 Function of the Reset/Prog button

⚠ Over this switch base settings at the Moco KNX/EIB can be made. These base settings are only possible in delivery status before the device is programmed with the ETS or after the device is unloaded by the ETS. The base settings are overwritten by the ETS settings.

#### 3.2 Selection of different user ergonomics

Over the Reset/Prog button different switch user ergonomics can be defined for the local switch inputs and/or Somfy RTS radio hand transmitters. These settings are only possible in delivery status before the device was programmed with the ETS or after the device became to unload by the ETS. As soon as the device was programmed with the ETS the user ergonomics can no more be made over the Reset/Prog button. If the device became to unload by the ETS, setting of the user ergonomics is again possible over the Reset/Prog button.

⚠ The selection of the user ergonomics should be consistent with the appropriate end product.



- ))) = Configuration of the animeo RTS radio module
- SCR = Screen ergonomics\*
- EU = Venetian blind, EU ergonomics\*
- US = Venetian blind, US Ergonomics\*

\* see Chapter 0 Definitions

#### Change the ergonomics

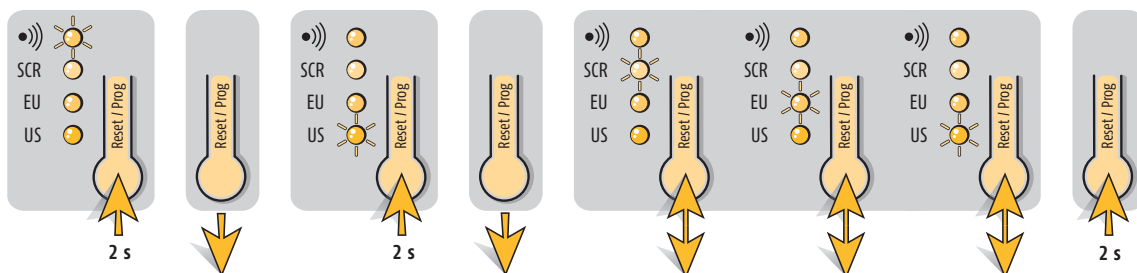

The delivery status is venetian blind with EU ergonomics.

To switch between the different ergonomic press shortly the Reset/Prog button. Continue to do so until the desired LED is lighting.

2 s

2 s

2 s

2 s

2 s

2 s

2 s

2 s

2 s

2 s

### 3.3 Manual setting of the running and tilting times

Over the local conventional switch and by radio hand transmitters the running and tilting times per motor output can be adjusted. These settings are only possible on delivery status before the device is programmed with the ETS. As soon as the device is programmed with the ETS, the running and tilting times cannot be programmed over the local conventional switches or by radio hand transmitters. If the device is unloaded by the ETS, it is again possible to program the running and tilting times over the local conventional switches or by radio hand transmitters.

#### Teach running and tilting time/-length

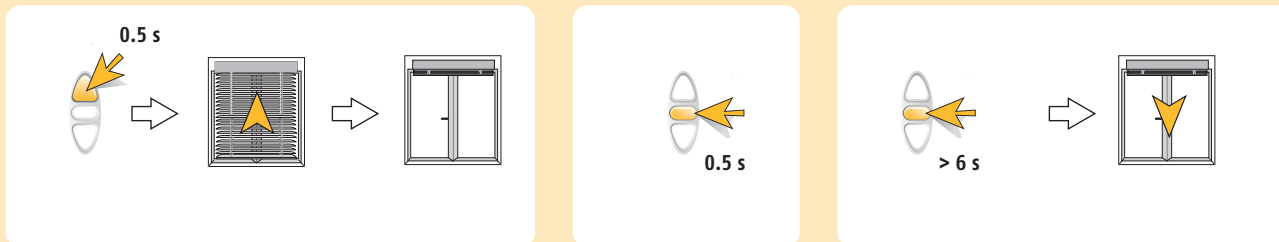

⚠ Press immediately when lower end limit is reached.

⚠ Keep stop pressed during entire tilting



### 3.4 Manual setting of the intermediate position 1

Intermediate position 1 can also be programmed over a conventional local switch or by radio hand transmitters individually per motor output. At the same time it is possible to define the intermediate position 1 over settings in the ETS parameters. Before the intermediate position 1 is programmed it is obligatory to set the running and tilting times.

⚠ The last learned position is valid.

#### Saving

1 Drive screen in desired position



⚠ With conventional unlocked push buttons the stop order can be generated by pressing the up and down button simultaneously

2 Store position

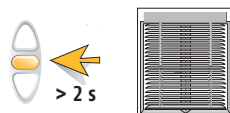

⚠ Whilst saving the screen tilts shortly up and down

#### Call in

1

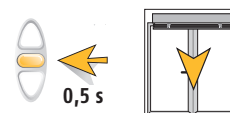

⚠ The stored position will be driven

### 3.5 Reset to delivery status

1. If the device has not yet been programmed with the ETS software.

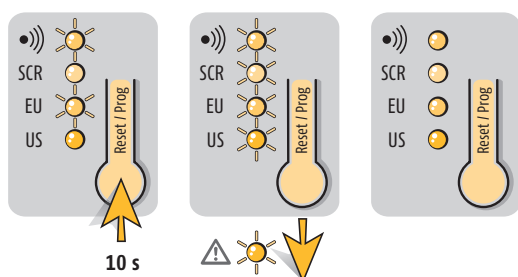

#### Complete reset:

The configurations realized over the Reset/Prog button, local conventional push buttons or radio transmitters can be reset over the Reset/Prog button by pressing 10 s.



- If the device with the ETS has already been programmed.

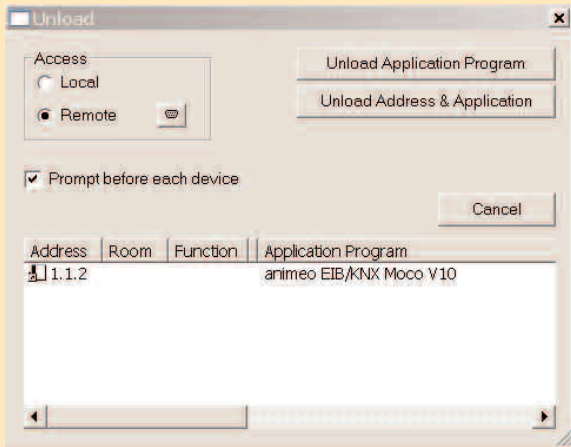

If the device with the ETS has already been programmed, a reset to delivery status is not possible over the Reset/Prog button. Over the function "Unload" in the ETS all settings of the device can be reset to delivery status. The Reset/Prog button can then be used again.

## 4 Communication objects

A maximum of 100 communication objects are available, which however cannot be used at one time. Maximally 95 group addresses can be linked.

No.	Objekt name	Type	Description
0	Motor 1 UP/DOWN, CLOSE/OPEN	1 Bit (EIS 7)	<p>If a telegram with the value "0" is received on this communication object, the appropriate blind goes up or the window closes. If a telegram with the value "1" is received, the appropriate blind goes down or the window opens. At expiration of the adjusted running time for the UP and DOWN direction the relays of the outputs are activated.</p> <p><b>For venetian blinds:</b> If the venetian blind is in a fully moving process, the venetian blind stops with the receipt of a telegram on the appropriate object, independently whether a telegram with the value "0" or "1" is received. If the venetian blind is in passive state, a step will be executed whereas with the receipt of a telegram with the value "1" the slat will close and with the receipt of a telegram with the value "0" the slat will open. The step length is de-fined in the parameter settings for the appropriate motor.</p> <p><b>For screens, roller blinds, awnings and windows:</b> If one of these end products is in a fully moving process, the end product stops with the receipt of a telegram on the appropriate object, independently of whether a telegram with the value "0" or "1" is received. If one of these end products is in passive state, then with the receipt of a telegram on one of these communication objects no action is executed.</p>
1	Motor 2 UP/DOWN, CLOSE/OPEN	1 Bit (EIS 7)	
2	Motor 3 UP/DOWN, CLOSE/OPEN	1 Bit (EIS 7)	
3	Motor 4 UP/DOWN, CLOSE/OPEN	1 Bit (EIS 7)	
4	Motor 1 STEP / STOP	1 Bit (EIS 7)	
5	Motor 2 STEP / STOP	1 Bit (EIS 7)	
6	Motor 3 STEP / STOP	1 Bit (EIS 7)	
7	Motor 4 STEP / STOP	1 Bit (EIS 7)	
8	Motor 1 Position UP / DOWN	1 Byte (EIS 6)	<p>If one of these communication objects receives a telegram, the appropriate blind will go into the position which is defined by the received value. "0" = UP "255" = DOWN</p> <p><b>For venetian blinds:</b> If the position is reached, the same slat angle starts up in which the venetian blind was previously.</p>
9	Motor 2 Position UP / DOWN	1 Byte (EIS 6)	
10	Motor 3 Position UP / DOWN	1 Byte (EIS 6)	<p><b>For venetian blinds:</b> If one of these communication objects receives a telegram, the appropriate slat will go to that position which is defined by the received value. If the venetian blind is in full moving process while receiving a telegram on the appropriate object, the position of the slat will be started up when the drive is finished. Depending on the parameter setting on parameter card „General“ the position is defined as follows:</p> <p>"255" = slat maximal closed / "0" = slat maximal reversed or "0" = slat maximal closed / "255" = slat maximal reversed</p>
11	Motor 4 Position UP / DOWN	1 Byte (EIS 6)	
12	Motor 1 Slat position	1 Byte (EIS 6)	
13	Motor 2 Slat position	1 Byte (EIS 6)	
14	Motor 3 Slat position	1 Byte (EIS 6)	
15	Motor 4 Slat position	1 Byte (EIS 6)	

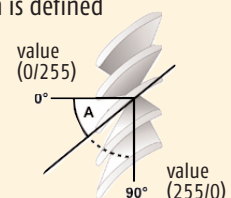

Nr.	Objektname	Typ	Beschreibung
16	Motor 1 Move to IP 1	1 Bit (EIS 1)	If a telegram with the value "1" is received on this communication object, the appropriate blind goes to the intermediate position 1 which was configured by local switch or by remote control or parameterised in the ETS parameters. The last position which has been configured is active. Receiving a telegram with the value "0" on one of these communication objects the appropriate blind goes to the upper end position.
17	Motor 2 Move to IP 1	1 Bit (EIS 1)	
18	Motor 3 Move to IP 1	1 Bit (EIS 1)	
19	Motor 4 Move to IP 1	1 Bit (EIS 1)	
20	Motor 1-4 Move to IP 1	1 Bit (EIS 1)	If a telegram with the value "1" is received on this communication object, the blinds 1-4 go to the intermediate position 1 which was configured by local switch or by remote control and parameterised in the ETS parameters. The position which has been configured at last is active. Receiving a telegram with the value "0" on one of these communication objects the blinds 1-4 go to the upper end position.
21	Motor 1 Move to IP 2	1 Bit (EIS 1)	If a telegram with the value "1" is received on this communication object, the appropriate blind goes to the intermediate position 2 which was parameterised in the ETS parameters. Receiving a telegram with the value "0" on one of these communication objects the blind goes to the upper end position.
22	Motor 2 Move to IP 2	1 Bit (EIS 1)	
23	Motor 3 Move to IP 2	1 Bit (EIS 1)	
24	Motor 4 Move to IP 2	1 Bit (EIS 1)	
25	Motor 1-4 Move to IP 2	1 Bit (EIS 1)	If a telegram with the value "1" is received on this communication object, the blinds 1-4 go to the intermediate position 2 which was parameterised in the ETS parameters. Receiving a telegram with the value "0" on one of these communication objects the blinds 1-4 go to the upper end position.
26	Motor 1 Security, low prio	1 Bit (EIS 1)	If a telegram with the value "1" is received on this communication object, the appropriate blind goes to the position which was parameterised in the ETS parameters. When one of the communication objects receives a telegram with value "0" no action will be executed. Only with the selection "Repeat the last telegram after security (Yes)" in the ETS parameters this action will be executed on the appropriate blind. If one of these communication objects is active through a telegram with the value "1" and if then on one of the communication objects 31-34 (security position, high priority) a telegram with value "1" is received, the appropriate blind will move to the position configured in the ETS parameters (security position, high priority).
27	Motor 2 Security, low prio	1 Bit (EIS 1)	
28	Motor 3 Security, low prio	1 Bit (EIS 1)	
29	Motor 4 Security, low prio	1 Bit (EIS 1)	
30	Motor 1-4 Security, low prio	1 Bit (EIS 1)	If a telegram with the value "1" is received on this communication object, the blinds 1-4 go to the position which was parameterised in the ETS parameters. When the communication object receives a telegram with value "0" no action will be executed. Only with the selection "Repeat the last telegram after security (Yes)" in the ETS parameters this action will be executed on the blinds 1-4. If this communication object is active through a telegram with the value "1" and if then, on the communication object 35 (security position, high priority) a telegram with the value "1" is received the blinds 1-4 will move to the position configured in the ETS parameters (security position, high priority).
31	Motor 1 Security, high prio	1 Bit (EIS 1)	If a telegram with the value "1" is received on this communication object, the appropriate blind goes to the position which was parameterised in the ETS parameters. When one of the communication objects receives a telegram with value "0" no action will be executed. Only with the selection "Repeat the last telegram after security (Yes)" in the ETS parameters this will be executed in the appropriate blind. If an object for security position, low priority is active ("1"), the appropriate parameterised position will be started up.
32	Motor 2 Security, high prio	1 Bit (EIS 1)	
33	Motor 3 Security, high prio	1 Bit (EIS 1)	
34	Motor 4 Security, high prio	1 Bit (EIS 1)	
35	Motor 1-4 Security, high prio	1 Bit (EIS 1)	If a telegram with the value "1" is received on this communication object, the blinds 1-4 go to the position which was parameterised in the ETS parameters. When the communication object receives a telegram with value "0" no action will be executed. Only with the selection "Repeat the last telegram after security (Yes)" in the ETS parameters this action will be executed in the blinds 1-4. If an object for security position, low priority is active ("1") the appropriate parameterised position will be started up.

Nr.	Objektname	Typ	Beschreibung
36	Mains power failure (230 V)	1 Bit (EIS 1)	With this communication object a mains voltage failure can be signaled. As soon as the mains voltage precipitates a telegram with the value "1" it is sent to the bus. With mains voltage return this communication object sends a telegram with the value "0".
37	Motor 1 Feedback UP / DOWN	1 Byte (EIS 6)	On these communication objects the current position (UP / DOWN direction) of the respective blind is sent to the bus based on the programmed running time. The type of feedback (on demand, status change, cyclic) is defined in the ETS parameters. "0" = UP / "255" = DOWN
38	Motor 2 Feedback UP / DOWN	1 Byte (EIS 6)	
39	Motor 3 Feedback UP / DOWN	1 Byte (EIS 6)	
40	Motor 4 Feedback UP / DOWN	1 Byte (EIS 6)	
41	Motor 1 Feedback Slat	1 Byte (EIS 6)	On these communication objects the current slat position of the respective blind is sent to the bus based on the programmed tilting time. The type of feedback is defined in the ETS parameters. Depending on the parameter setting on parameter card "General" the position is defined as follows: "255" = slat maximal closed / "0" = slat maximal reversed or "255" = slat maximal closed / "0" = slat maximal reversed
42	Motor 2 Feedback Slat	1 Byte (EIS 6)	
43	Motor 3 Feedback Slat	1 Byte (EIS 6)	
44	Motor 4 Feedback Slat	1 Byte (EIS 6)	
45	Motor 1-4 Status positions	1 Bit (EIS 1)	On this communication object if a telegram with the value "1" or "0" is received, then the current status positions are sent on the bus (objects 37-44).
46	Motor 1 Upper end position	1 Bit (EIS 1)	Over these communication objects for the appropriate blind a telegram with the value "1" is sent if the upper end position is reached. When leaving the upper end position of the appropriate blind a telegram with the value "0" is sent. The upper and the lower end position result from the parameterised running times.
47	Motor 2 Upper end position	1 Bit (EIS 1)	
48	Motor 3 Upper end position	1 Bit (EIS 1)	
49	Motor 4 Upper end position	1 Bit (EIS 1)	
50	Motor 1-4 Upper end position	1 Bit (EIS 1)	Over this communication object for the blinds 1-4 a telegram with the value "1" is sent if all 4 blinds have reached the upper end position. If all 4 blinds have left the upper end position, a telegram with the value "0" is sent.
51	Motor 1 Lower end position	1 Bit (EIS 1)	Over these communication objects for the appropriate blind a telegram with the value "1" is sent after the lower end position is reached. When leaving the lower end position of the appropriate blind a telegram with the value "0" is sent. The upper and the lower end position result from the parameterised running times.
52	Motor 2 Lower end position	1 Bit (EIS 1)	
53	Motor 3 Lower end position	1 Bit (EIS 1)	
54	Motor 4 Lower end position	1 Bit (EIS 1)	
55	Motor 1-4 Lower end position	1 Bit (EIS 1)	Over this communication object for the blinds 1-4 a telegram with the value "1" is sent after all 4 blinds have reached the lower end position. After all 4 blinds have left the lower end position, a telegram with the value "0" is sent. The upper and the lower end position result from the parameterised running times.
56	Motor 1 Block functions	1 Bit (EIS 1)	On one of these communication objects if a telegram with the value "1" is received the functions which are selected in ETS parameters will be blocked for the appropriate blind. If on one of these communication objects a telegram with the value "0" is received the functions for the appropriate blind will be enabled again.
57	Motor 2 Block functions	1 Bit (EIS 1)	
58	Motor 3 Block functions	1 Bit (EIS 1)	
59	Motor 4 Block functions	1 Bit (EIS 1)	
60	Motor 1-4 Block functions	1 Bit (EIS 1)	On this communication object if a telegram with the value "1" is received the functions which are selected in ETS parameters will be blocked for the blinds 1-4. If on this communication object a telegram with the value "0" is received the functions for the blind 1-4 will be enabled again.

Nr.	Objektname	Typ	Beschreibung
61	Motor 1 Prio automatic/manual	1 Bit (EIS 1)	Over these communication objects priority between automatic functions and manual functions can be switched. If on one of these communication objects a telegram with the value "1" is received priority automatic functions is active for the appropriate blind. If on one of these communication objects a telegram with the value "0" is received priority manual functions are active for the appropriate blind.
62	Motor 2 Prio automatic/manual	1 Bit (EIS 1)	
63	Motor 3 Prio automatic/manual	1 Bit (EIS 1)	
64	Motor 4 Prio automatic/manual	1 Bit (EIS 1)	
65	Motor 1 Reset priority	1 Bit (EIS 1)	If on one of these communication objects a telegram with the value "1" or "0" is received the appropriate priority for the appropriate blind is reset. Priority automatic functions or priority manual functions are then again actively switched. The active priority depends on which communication object is active and/or which priority has been selected in the ETS parameters.
66	Motor 2 Reset priority	1 Bit (EIS 1)	
67	Motor 3 Reset priority	1 Bit (EIS 1)	
68	Motor 4 Reset priority	1 Bit (EIS 1)	
69	Input 1: UP / DOWN	1 Bit (EIS 1)	A long pressing of the switch at the input A generates a telegram with the value "0" on this communication object. The venetian blind goes UP. A long pressing of the switch at the input B generates a telegram with the value "1" on this communication object. The venetian blind goes DOWN.
70	Input 1: Step/Stop	1 Bit (EIS 1)	A short pressing of the switch at the input A generates a telegram with the value "0" on this communication object. The slat will tilt to reverse (open). If the venetian blind is in the fully moving process with a short pressing of the switch at the input A, a stop order is generated. A short pressing of the switch at the input B generates a telegram with the value "1" on this communication object. The slat will tilt to close. If the venetian blind is in a fully moving process with a short pressing of the switch at the input B a stop order is generated.
71	Input 1: A, Switch	1 Bit (EIS 1)	According to the parameter settings and the state at input 1, contact A, over this communication object a switching telegram with the value "1" or "0" is generated.
72	Input 1: B, Switch	1 Bit (EIS 1)	According to the parameter settings and the state at input 1, contact B, over this communication object a switching telegram with the value "1" or "0" is generated.
73	Input 1: A, 8-Bit value	1 Byte (EIS 6)	According to the parameter settings with a rising edge at the input 1, contact A, the configured value (0-255) is sent.
74	Input 1: B, 8-Bit value	1 Byte (EIS 6)	According to the parameter configurations with a rising edge at the input 1, contact B, the configured value (0-255) is sent.
75	Input 1: A/B, Dimming	1 Bit (EIS 2)	On/Off: According to the parameter settings of the input 1 contact A/B with a short actuation a telegram with the value "1" and/or "0" will be generated. Toggle/Toggle: According to the parameter settings of the input 1 contact A/B with a short actuation a telegram with the value "1" and/or "0" is generated.
76	Input 1: A/B, Dimming value	4 Bit (EIS 2)	Brighter/darker dimming: According to the parameter settings of the input 1 contact A with a long actuation it is dimmed brighter. According to the parameter settings of the input 1 contact B with a long actuation it is dimmed darker. Brighter/darker toggle: According to the parameter settings of the input 1 contact A with a long actuation it is dimmed 100 %. When releasing the appropriate switch at the input A a stop order is generated. The dimming action operated last is thus inverted. According to the parameter settings of the input 1 contact B with a long actuation it is dimmed 100 %. When releasing the appropriate switch at the input B a stop order is generated. The dimming action operated last is thus inverted.

Nr.	Objektname	Typ	Beschreibung
77	Input 2: UP / DOWN	1 Bit (EIS 7)	see description of object 69, C/D instead of A/B
78	Input 2: Step/Stop	1 Bit (EIS 7)	see description of object 70, C/D instead of A/B
79	Input 2: C, Switch	1 Bit (EIS 1)	see description of object 71, C instead of A
80	Input 2: D, Switch	1 Bit (EIS 1)	see description of object 72, D instead of B
81	Input 2: C, 8-Bit-value	1 Byte (EIS 6)	see description of object 73, C instead of A
82	Input 2: D, 8-Bit-value	1 Byte (EIS 6)	see description of object 74, D instead of B
83	Input 2: C/D, Dimming	1 Bit (EIS 2)	see description of object 75, C/D instead of A/B
84	Input 2: C/D, Dimming value	4 Bit (EIS 2)	see description of object 76, C/D instead of A/B
85	Input 3: UP / DOWN	1 Bit (EIS 7)	see description of object 69, E/F instead of A/B
86	Input 3: Step/Stop	1 Bit (EIS 7)	see description of object 70, E/F instead of A/B
87	Input 3: E, Switch	1 Bit (EIS 1)	see description of object 71, E instead of A
88	Input 3: F, Switch	1 Bit (EIS 1)	see description of object 72, F instead of B
89	Input 3: E, 8-Bit value	1 Byte (EIS 6)	see description of object 73, E instead of A
90	Input 3: F, 8-Bit value	1 Byte (EIS 6)	see description of object 74, F instead of B
91	Input 3: E/F, Dimming	1 Bit (EIS 2)	see description of object 75, E/F instead of A/B
92	Input 3: E/F, Dimming value	4 Bit (EIS 2)	see description of object 76, E/F instead of A/B
93	Input 4: UP / DOWN	1 Bit (EIS 7)	see description of object 69, G/H instead of A/B
94	Input 4: Step/Stop	1 Bit (EIS 7)	see description of object 70, G/H instead of A/B
95	Input 4: G, Switch	1 Bit (EIS 1)	see description of object 71, G instead of A
96	Input 4: H, Switch	1 Bit (EIS 1)	see description of object 72, H instead of B
97	Input 4: G, 8-Bit-value	1 Byte (EIS 6)	see description of object 73, G instead of A
98	Input 4: H, 8-Bit-value	1 Byte (EIS 6)	see description of object 74, H instead of B
99	Input 4: G/H, Dimming	1 Bit (EIS 2)	see description of object 75, G/H instead of A/B
100	Input 4: G/H, Dimming value	4 Bit (EIS 2)	see description of object 76, G/H instead of A/B

## 5. Parameters

The options of the individual parameters are described in each case. The default values are shown in *italics*. In the following illustrations of the different parameter cards a maximum of parameters is always presented.

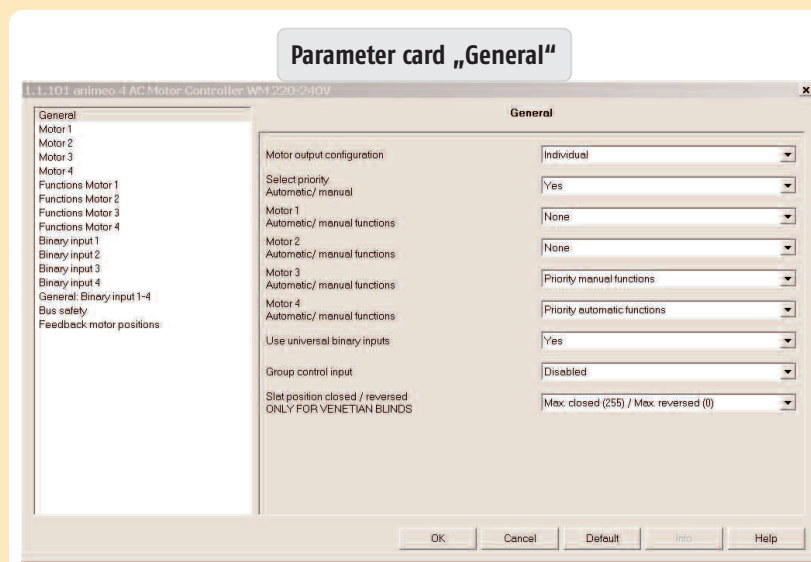

### Motor output configuration

- Options:
- *Combined*
  - *Individual*

With these parameters it can be specified whether the configurations of the motor outputs are to be done "Combined" or "Individual". If the parameter "Combined" is selected for the basic settings of all four motor outputs, only one parameter card will be visible (Motor 1-4).

⚠ This setting ("Combined") is recommendable for projects where the configurations of the motor outputs are equal.

If the parameter "Individual" is selected for the basic settings of the motor outputs four individual cards will be visible (Motor 1, Motor 2,...).



## Selection priority Automatic/manual

- Options:
- No
  - Yes

With this parameter the configurations for the priority become visible. The objects necessary for it appear simultaneously.

## Motor 1...4 Automatic/manual functions

- Options:
- None
  - Priority automatic functions
  - Priority manual functions

- **None:**  
The moving commands are processed in detailed order.
- **Priority automatic function:**  
If an automatic command (1 Byte move command) takes place before a manual command (1 Bit move command), all manual commands are disabled. Also the objects to move to the intermediate positions 1 and 2 (objects 16-25) are disabled. A manual command is generated also over the local switch inputs or the radio hand transmitter. A tilting command (1 Bit) can however, always be executed within the configured tilting time. A reset of the priority automatic function is effected if on the appropriate objects "Reset priority" (65-68) a telegram with the value "1" or "0" is received. Switching between priority manual functions (value "0") and priority automatic functions (value "1") is made by the appropriate objects (61-64). Following adjust-over, the appropriate priority is active again in the reset state. This means for priority automatic functions that the manual commands become again disabled only through the next automatic command.
- **Priority manual function:**  
If a manual command (1 Bit) takes place before an automatic command (1 Byte), all automatic commands are disabled. A manual command is generated also over the local switch inputs or the radio hand transmitter. A reset of the priority manual functions is effected if a telegram with the value "1" or "0" is received on the appropriate object "Reset priority" (65-68). Switching between priority manual functions (value "0") and priority automatic functions (value "1") is made by the appropriate objects (61-64). Following adjust-over, the appropriate priority is active again in the reset state. This means for functions priority manual that the automatic commands become again disabled only through the next manual command.  
△ See explanations in chapter 0.

△ Over the priority manual functions the user has the possibility to disable the automatic functions. For example, over a timer the user comfort can be defined. At 8:00 o'clock over the appropriate object (61-64) the priority manual functions are activated and the user can move the end product to a desired position with the next manual command. At 5:00 o'clock the priority automatic function is again activated. Over the appropriate object (61-64) it is always possible to switch between priority manual functions and priority automatic functions.

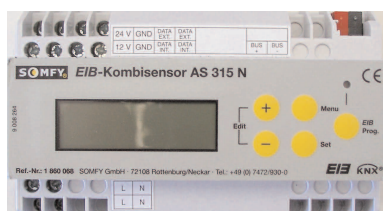
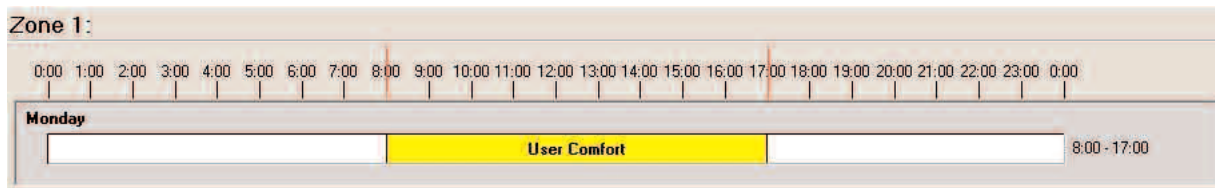

To use timer functions it is ideal to use the central unit AS 315 N (Ref. 1860069).

## Universal binary inputs use

- Options:
- No
  - Yes

With the parameter "Yes" four further parameter cards (binary input 1...4) are opened. The local switch inputs can be linked now over the appropriate objects (69-100). A conventional switch can be used thus for most diverse functions. For example switching, venetian blind function, dimming or sending values.

## Group control input

- Options:
- disabled
  - enabled

Over this parameter it can be specified whether the group control input is disabled or enabled. Over this input all four motors are moved at the same time. Independently of the parameter configurations the security configurations (objects 26-35) have higher priority. If one of the security objects is active the group control input is disabled.

△ With bus voltage failure this input is enabled even if it is disabled over the parameter configurations and can be used for an emergency operation. With bus power return this input is disabled or enabled according to the parameter configurations.

## Slat position closed/reversed ONLY FOR VENETIAN BLINDS

- Options:
- Max. closed (255) / Max. reversed (0)
  - Max. closed (0) / Max. reversed (255)

### • Max. closed (255) / Max. reversed (0)

If a value of „255“ is received by the appropriate object (12-15) the slat will be maximal closed.  
If a value of „0“ is received by the appropriate object (12-15) the slat will be maximal reversed (opened).

### • Max. closed (0) / Max. reversed (255)

If a value of „0“ is received by the appropriate object (12-15) the slat will be maximal closed.  
If a value of „255“ is received by the appropriate object (12-15) the slat will be maximal reversed (opened).

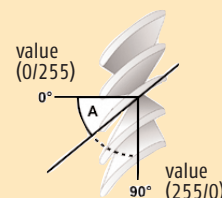

## Parameter card „motor 1...4 / motor 1-4“

Four individual parameter cards (Motor 1...4) become visible if on the parameter card "General" the motor output configuration is set to "Individual". Only one parameter card (Motor 1-4) becomes visible, if on the parameter card "General" the basic adjustment of the motors is set to "Common".

## Type of end product

- Options:
- Venetian blind with EU ergonomics
  - Venetian blind with US ergonomics
  - Screen, awning, roller blind
  - Windows

### • Venetian blind with EU ergonomics:

With this parameter it is specified that the venetian blind is in EU ergonomics over the local switch inputs or over Somfy RTS radio hand transmitter.

If the local switch inputs are used as universal binary inputs, the control ergonomics is defined over the appropriate parameters (short/long depressing the button).

△ See explanation EU, US, screen switch ergonomics in chapter 0.

### • Venetian blind with US ergonomics:

Over this parameter it is specified that the venetian blind is in US ergonomics over the local switch inputs or over Somfy RTS radio hand transmitter.

If the local switch inputs are used as universal binary inputs, the control ergonomics is defined over the appropriate parameters (short/long depressing of the button).

△ See explanation EU, US, screen switch ergonomics in chapter 0.

### • Screens, roller shutters, awnings:

Over this parameter it is specified that the appropriate blind is directed for move/stop commands, if the control is made by means of the local switch inputs or by Somfy RTS radio hand transmitter.

If the local switch inputs are used as universal binary inputs, the control ergonomics is defined over the appropriate parameters (short/long depressing of the button).

△ See explanation EU, US, screen switch ergonomics in chapter 0.

### • Windows

Over this parameter it is specified whether the appropriate window is directed for move/stop commands, if the control is made by means of the local switch inputs or by Somfy RTS radio hand transmitter.

If the local switch inputs are used as universal binary inputs, the control ergonomics is defined over the appropriate parameters (short/long depressing of the button).

△ See explanation EU, US, screen ergonomics in chapter 0.

## Running time UP / OPEN (1 - 320 s)

- Options:
- 120
  - 1 - 320 seconds

The configured time here is the maximum running time from the lower end position to the upper end position and/or the maximum running time that one window motor needs in order to close the appropriate window. An overlapping time of 5 seconds is always added except in case of positioning telegrams (objects 8-11). However, if a telegram with the value "0" is received by the appropriate object (objects 8-11) an overlapping time of 5 seconds is added.

## Running time DOWN / CLOSE (1 - 320 s)

- Options:
- 120
  - 1 - 320 seconds

The configured time here is the maximum running time from the upper end position into the lower end position, and/or the maximum running time a particular window motor needs, in order to open the appropriate window. An overlapping time of 5 seconds is always added except in the case of positioning telegrams (objects 8-11). However, if a telegram with the value "255" is received by the appropriate object (objects 8-11) an overlapping time of 5 seconds is added.

## Complete tilting time

### Basis 0,05 s (0 - 200)

- Options:
- 20
  - 0 - 200

The configured time here defines the complete tilting time of the slat. This parameter is visible only if as type of end product either venetian blind with EU ergonomics or venetian blind with US ergonomics were selected.



### Step length

Basis 0,05 s (0 - 200)

- Options:
- 2
  - 0 - 200

The configured time here defines the time for a tilting step. This parameter is visible only if as type of end product either venetian blind with EU ergonomics or venetian blind with US ergonomics were selected.

### Slack compensation

0,05 s (0 - 200)

- Options:
- 0
  - 0 - 200

The time for slack compensation is active as soon as a higher value than "0" is registered. The time configured here defines the time to add to the complete tilting time in order to adjust mechanical tolerances. This time is always added with the first UP (reverse/open) command of the slat if as type of end product either venetian blind with EU ergonomics or venetian blind with US ergonomics were selected.

### Security position

Low priority

- Options:
- Upper end position
  - Lower end position
  - Intermediate position 1
  - Intermediate position 2
  - *Security ignore*
  - Stop
  - Close window
  - Open window

Over this parameter the security position "low security" is specified for the appropriate blind. If on one of the communication objects (objects 26-30) a telegram with the value "1" is received, then the appropriate blind moves to the position which is configured in the ETS parameters. If on one of these communication objects a telegram with the value "0" is received no action will be executed. Only if in the ETS parameters "Repeat the last telegram after security (Yes)" is selected, then this action for the appropriate blind will be executed. If one of these communication objects is active by a telegram with the value "1" and on one of the communication objects 31-34 (security position, high priority) a telegram with the value "1" is received, the appropriate blind moves to the position configured in the ETS parameters (security position, high priority).

### Security position

High priority

- Options:
- *Upper end position*
  - Lower end position
  - Security ignore
  - Stop
  - Close window
  - Open window

Over this parameter the security position "high security" is specified for the appropriate blind. If on one of the communication objects (objects 31-35) a telegram with the value "1" is received, then the appropriate blind moves to the position configured in the ETS parameters. If on one of these communication objects a telegram with the value "0" is received no action will be executed. Only if in the ETS parameters "Repeat the last telegram after security (Yes)" is selected, then this action for the appropriate blind will be executed.

### Cyclic monitoring time in seconds (0 - 255)

- Options:
- 0
  - 0 - 255

Cyclic monitoring time is active as soon as a higher value than "0" is registered and refers to both security objects, low and high priority.

△ With active cyclic monitoring it is to be made certain that the time of the cyclic transmitter is smaller, approx. 1/4 than the configured cyclic monitoring time for the security objects, low and high priority.

If the default value remains adjusted "0" the security objects react statically to the values "1" and "0".

## Parameter card „Functions motor 1...4 / Functions motor 1-4“

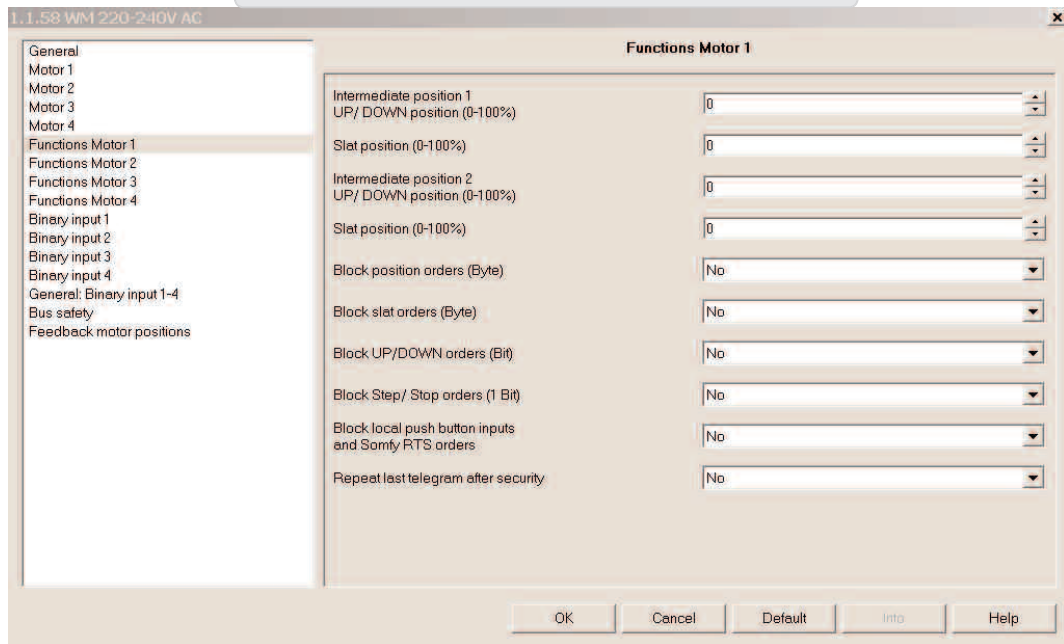

Four individual parameter cards (Functions Motor 1...4) become visible if on the parameter card "General" the basic adjustment of the motors is set to "Individual". Only one parameter card (Functions Motor 1-4) becomes visible, if on the parameter card "General" the basic adjustment of the motors is set to "Common".

### Intermediate position 1 UP / DOWN position (0 - 100 %)

- Options:
- 0
  - 0 - 100

With this parameter the intermediate position 1 "UP / DOWN" is defined. The adjusted value in % refers to the configured running time of the appropriate blinds of the parameter cards Motor 1...4/Motor 1-4.

### Slat position (0 - 100 %)

- Options:
- 0
  - 0 - 100

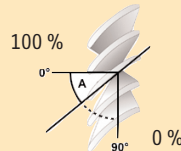

With this parameter the slat position of the intermediate position 1 is defined. The adjusted value in % refers to the configured complete tilting time of the appropriate venetian blind of the parameter cards Motor 1...4/Motor 1-4.

△ Intermediate position 1 can be stored also over the conventional local switch or individually by radio hand transmitters per motor output. The position learned last is valid.

### Intermediate position 2 UP / DOWN position (0 - 100 %)

- Options:
- 0
  - 0 - 100

With this parameter the intermediate position 2 "UP / DOWN" is defined. The adjusted value in % refers to the configured running time of the appropriate blinds of the parameter cards Motor 1...4/Motor 1-4.

### Slat position (0 - 100 %)

- Options:
- 0
  - 0 - 100

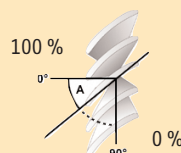

With this parameter the slat position of the intermediate position 3 is defined. The adjusted value in % refers to the configured complete tilting time of the appropriate venetian blind of the parameter cards Motor 1...4/Motor 1-4.

### Block position orders (Byte)

- Options:
- No
  - Yes

Over this parameter the move orders (Byte) can be blocked by object (56–60). If the appropriate object receives a telegram with the value "1" during a blind is in full moving process, this action will first be executed completely. Only then, further move commands (Byte) are blocked. If the appropriate object receives a telegram with the value "0" the move orders (Byte) are again enabled.

### Block slat orders (1 Bit)

- Options:
- No
  - Yes

Over this parameter the slat tilting orders (Byte) can be blocked by object (56–60). If the appropriate object receives a telegram with the value "1" when the slats of a venetian blind are in full moving process, this action will first be executed completely. Only then, further tilting orders (Byte) are closed. If the appropriate object receives a telegram with the value "0" the slat tilting orders (Byte) are again enabled.

### Block UP / DOWN orders (1 Bit)

- Options:
- No
  - Yes

Over this parameter the move orders (1 Bit) can be blocked by object (56–60). If the appropriate object receives a telegram with the value "1" when a blind is in full moving process, this action will first be executed completely. Only then, further move orders (1 Bit) are blocked. If the appropriate object receives a telegram with the value "0", move orders (1 Bit) are again enabled.

### Block step/stop orders (1 Bit)

- Options:
- Nein
  - Ja

Over this parameter the step/stop and/or tilting order (1 Bit) can be blocked by object (56–60). If the appropriate object receives a telegram with the value "1" when the slat of a venetian blind is tilting this action will first be executed completely. Only then, further tilting orders (1 Bit) are blocked. If the appropriate object receives a telegram with the value "0", step/stop orders (1 Bit) are again enabled.

### Block local push button inputs and Somfy RTS orders

- Options:
- No
  - Yes

Over this parameter the local push button inputs and the Somfy RTS radio orders can be blocked by object (56–60). If the appropriate object receives a telegram with the value "1" when an end product is in full moving process, this action will first be executed completely. Only then, further commands over the local push button inputs and the Somfy RTS radio will be blocked. If the appropriate object receives a telegram with the value "0" the local push button inputs and the Somfy RTS radio orders are again enabled.

### Repeat last telegram after security

- Options:
- No
  - Yes

If this parameter is set on "Yes" the last move command after security is repeated. This means, the according blind will move to the position at which it was previously before on one of the security objects, low or high security, a telegram with the value "1" was received.

## Parameter cards „Binary input 1...4“

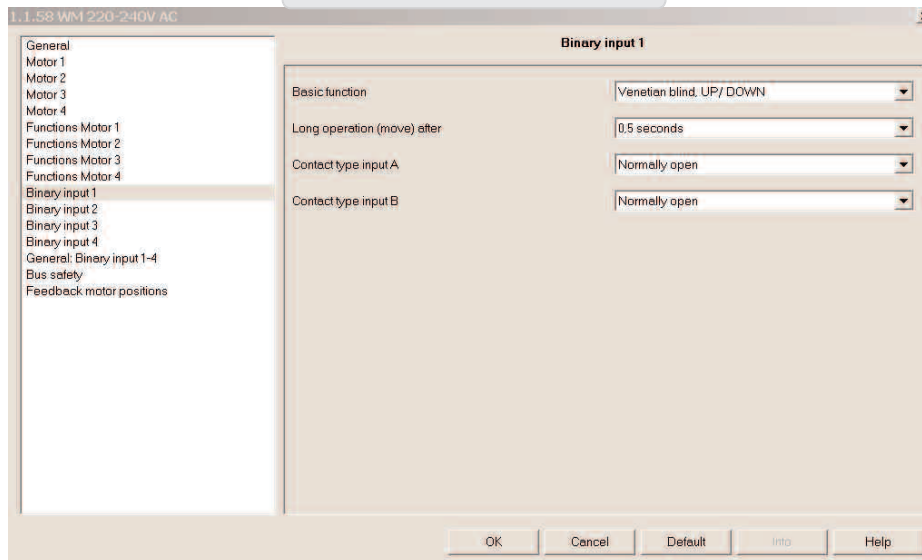

### General information

For each binary input four different basic functions are available:

- *Venetian blind UP / DOWN*
- *Switch/dry contact*
- *8-Bit value (rising edge)*
- *Dimming*

The individual functions and parameters depend on the selection of the basic function and are now described. The four different possibilities are described using screenshots of the binary input 1, contact A/B and are identical for the binary inputs 2-4, contacts C/D, E/F and G/H. The default value of the basic function for the parameter cards binary input 1...4 is venetian blind, UP / DOWN.

△ When the basic function "Venetian blind, UP / DOWN" is selected please be certain about which contact controls the UP order and which contact controls the DOWN order. The same attention is necessary when the basic function "Dimming" is selected. Please be certain about which contact controls dimming brighter and which contact controls dimming darker.

### Basic function

- Options:
- *Venetian blind UP / DOWN*
  - *Switch/dry contact*
  - *8-Bit value (rising edge)*
  - *Dimming*

### Long operating (move) after

- Options:
- *0,5 seconds*
  - *0,3...5,0 seconds*

This parameter defines the operating time of the appropriate switch, which differentiates between sending a short-term telegram (step/stop) and a long-term telegram (UP / DOWN motor). If the time is, for example, set to 0,5 seconds, only with a duration of application which is generated longer than 0,5 seconds, a long-term telegram will be executed. With duration of an application which is smaller than 0.5 seconds a short-term telegram is generated.

### Contact type input A

- Options:
- *Normally open*
  - *Normally closed*

Specified over this parameter is the contact type at the local input A. Normally open contact: The contact at the local input is not operated open and operated closed. Normally closed contact: The contact at the local input is operated opened and not operated closed.

### Contact type input B

- Options:
- *Normally open*
  - *Normally closed*

Specified over this parameter is the contact type at the local input B. Normally open contact: The contact at the local input is not operated open and operated closed. Normally closed contact: The contact at the local input is operated opened and not operated closed.

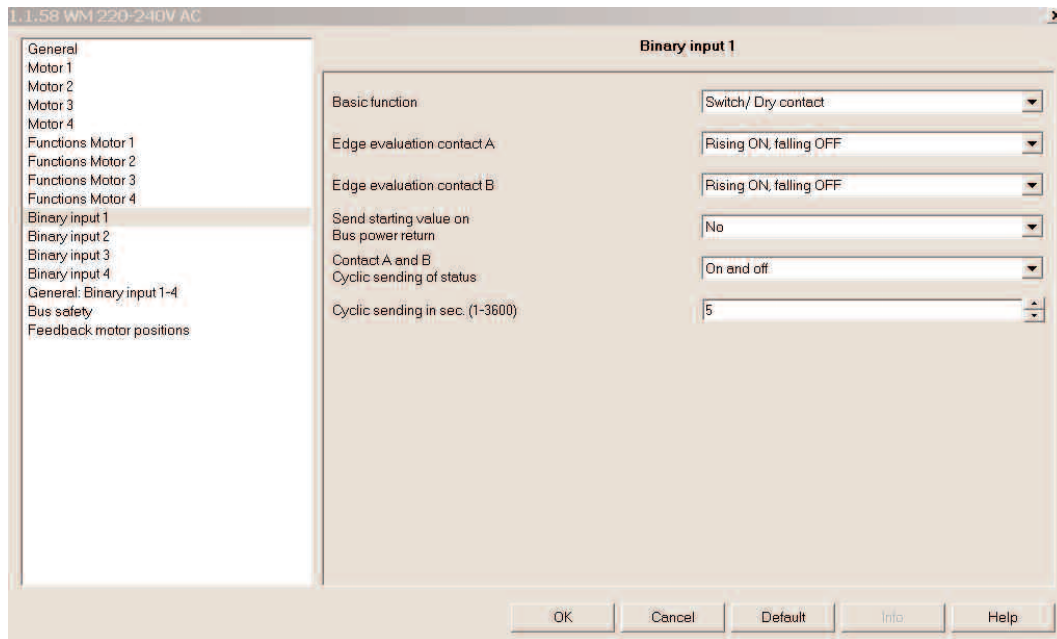

### Basic function

- Options:
- *Venetian blind UP / DOWN*
  - Switch/dry contact
  - 8-Bit value (rising edge)
  - Dimming

### Edge evaluation contact A

- Options:
- *Rising ON, falling OFF*
  - Rising OFF, falling ON
  - Rising ON
  - Falling ON
  - Rising OFF
  - Falling OFF
  - Rising toggle
  - Falling toggle
  - Rising toggle, falling toggle
  - No evaluation

On ("1") Off ("0") Toggle ("1/0")

Depending on which edge evaluation was selected the appropriate object value "0" or "1" will be generated.

- ***Rising ON, falling OFF***

If a rising edge at the local input appears, the object value "ON" is produced. If a falling edge at the local input appears, the object value "OFF" is produced. The duration of the manipulation is not evaluated.

- ***Rising OFF, falling ON***

If a rising edge at the local input appears, the object value "OFF" is produced. If a falling edge at the local input appears, the object value "ON" is produced. The duration of the manipulation is not evaluated.

- ***Rising ON***

If a rising edge at the local input appears, the object value "ON" is produced. If a falling edge at the local input appears, this is not evaluated. The duration of the manipulation is not evaluated.

- ***Falling ON***

If a falling edge at the local input appears, the object value "ON" is produced. If a rising edge at the local input appears, this is not evaluated. The duration of the manipulation is not evaluated.

- ***Rising OFF***

If a rising edge at the local input appears, the object value "OFF" is produced. If a falling edge at the local input appears, this is not evaluated. The duration of the manipulation is not evaluated.

- ***Falling OFF***

If a falling edge at the local input appears, the object value "OFF" is produced. If a rising edge at the local input appears, this is not evaluated. The duration of the manipulation is not evaluated.

- **Rising toggle**

If a rising edge at the local input appears, the object value is inverted. If a falling edge at the local input appears, this is not evaluated. The duration of the manipulation is not evaluated.

- **Falling toggle**

If a falling edge at the local input appears, the object value is inverted. If a rising edge at the local input appears, this is not evaluated. The duration of the manipulation is not evaluated.

- **Rising toggle, falling toggle**

If a rising or falling edge at the local input appears, the object value is inverted. The duration of the manipulation is not evaluated.

- **No evaluation**

If a rising or falling edge at the local input appears, this is not evaluated.

### Edge evaluation contact B

- Options:
- *Rising ON, falling Off*
  - Rising OFF, falling ON
  - Rising ON
  - Falling ON
  - Rising OFF
  - Falling OFF
  - Rising toggle
  - Falling toggle
  - Rising toggle, falling toggle
  - No evaluation

Description see "Edge evaluation contact A"

### Send starting value on bus power return

- Options:
- Yes
  - No

If this parameter is set to "Yes" with bus power return the current status of the input is then sent. If this parameter is set to "No" the current adjusted status of the input is not sent.

### Contact A and B

#### Cyclic sending of status

- Options:
- *No cyclic sending*
  - On
  - Off
  - On and off

Over this parameter it is specified whether the appropriate switching value of the communication object is to be sent cyclically.

- **No cyclic sending**

The switching value of the communication object is not cyclically sent.

- **On**

Only if the object value is "1" is it cyclically sent. If the object value changes due to a change of edge status at the input or due to a receipt of a Bus telegram from "0" to "1", the cyclic sending is stopped.

- **Off**

Only if the object value is "0" is it cyclically sent. If the object value changes due to a change of edge status at the input or due to a receipt of a Bus telegram from "1" to "0", the cyclic sending is stopped.

- **On and Off**

If the object value is "1" or "0" then the appropriate one is cyclically sent. If the object value changes due to a change of edge status at the input or due to a receipt, a bus telegram of the new value is sent.

### Cyclic sending in seconds (1 - 3600)

- Options:
- 5
  - 1 - 3600

Over this parameter the time intervals are fixed in which the appropriate object value is sent cyclically.

△ With active cyclic sending it is to be made certain that the time of the cyclic time received is greater approx. 1/4 than the configured cyclic time of the sender.

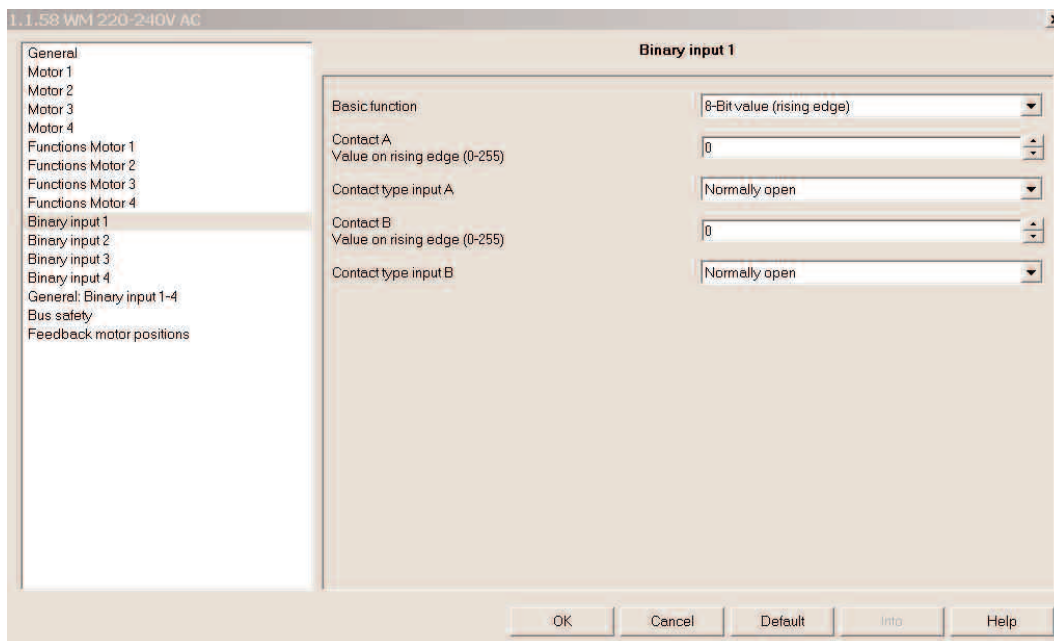

### Basic function

- Options:
- Venetian blind UP / DOWN
  - Switch/dry contact
  - 8-Bit value (rising edge)
  - Dimming

### Contact A

#### Value on rising edge (0 - 255)

- Options:
- 0
  - 0 - 255

Over this parameter the value is adjusted which is sent with receipt of a rising edge at the local input 1 contact A.

### Contact type input A

- Options:
- Normally open
  - Normally closed

Specified over this parameter is the contact type at the local input A. Normally open contact: The contact at the local input is not operated open and operated closed. Normally closed contact: The contact at the local input is operated opened and not operated closed.

### Contact B

#### Value on rising edge (0 - 255)

- Options:
- 0
  - 0 - 255

Over this parameter the value is adjusted which is sent with receipt of a rising edge at the local input 1 contact B.

### Contact type input B

- Options:
- Normally open
  - Normally closed

Specified over this parameter is the contact type at the local input B. Normally open contact: The contact at the local input is not operated open and operated closed. Normally closed contact: The contact at the local input is operated opened and not operated closed.

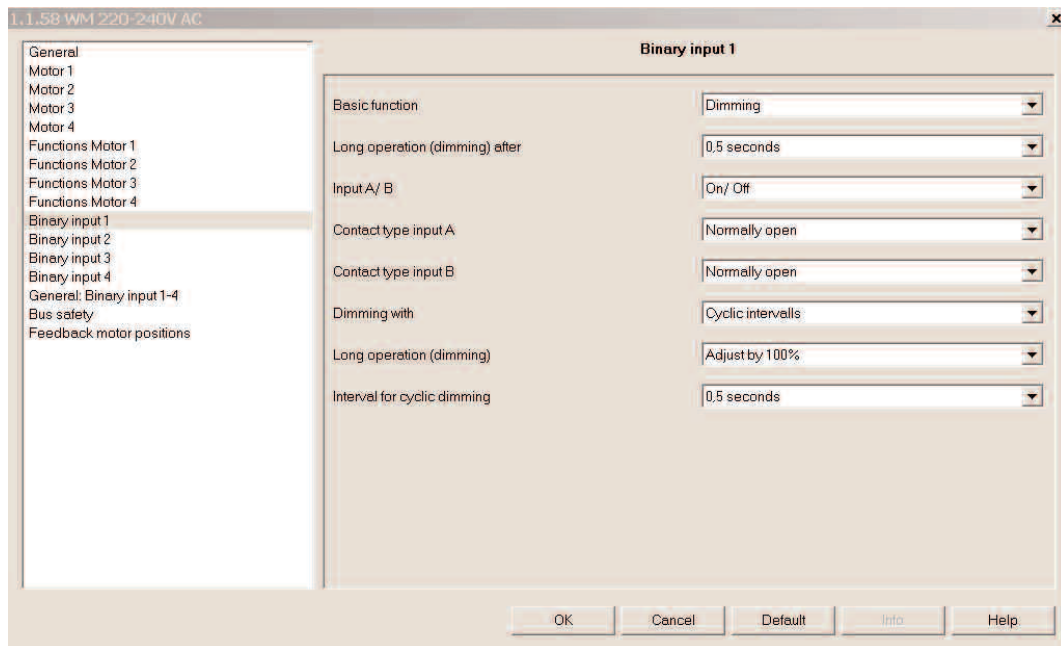

### Basic function

- Options:
- *Venetian blind UP / DOWN*
  - *Switch/dry contact*
  - *8-Bit value (rising edge)*
  - Dimming

### Long operation (dimming) after

- Options:
- *0,5 seconds*
  - *0,3 - 5,0 seconds*

This parameter defines the operating time of the appropriate switch, which differentiates between sending a switching telegram and a dimming telegram. If the time is, for example, set at *0,5 seconds*, only with duration of an application which is longer than *0,5 seconds* a dimming telegram is generated. With duration of application which is smaller than *0,5 seconds*, a switching telegram is generated.

### Input A/B

- Options:
- *On/Off*
  - *Toggle/toggle*
- On ("1")   Off ("0")   Toggle ("1/0")

This parameter defines the value which is sent with short manipulation of the appropriate input.

#### • *On/Off*

With a short manipulation of the switch at the input A an "Off" telegram is generated. With a short manipulation of the switch at the input B an "On" telegram is generated. These functions can be inverted by changing the wiring.

#### • *Toggle/toggle*

With every short manipulation of the switch at the input A or B, toggling occurs. This means the value that is in the appropriate switching object is inverted and then sent.

### Contact type input A

- Options:
- *Normally open*
  - *Normally closed*

Specified over this parameter is the contact type at the local input A. Normally open contact: The contact at the local input is not operated open and operated closed. Normally closed contact: The contact at the local input is operated opened and not operated closed.



## Contact type input B

- Options:
- *Normally open*
  - *Normally closed*

Specified over this parameter is the contact type at the local input B. Normally open contact: The contact at the local input is not operated open and operated closed. Normally closed contact: The contact at the local input is operated opened and not operated closed.

## Dimming with

- Options:
- *Stop telegram*
  - *Cyclic intervals*

### • *Stop telegram*

With a short manipulation of the switch at the local input 1 contact A or B a telegram is generated over the appropriate object (1 Bit). With a long manipulation of the switch at the local input A brightness is dimmed further over the appropriate object (4 Bit).

With a long manipulation of the switch at the local input B over the appropriate object (4 Bit) more darkness is dimmed. When releasing the appropriate switch at the local input 1 contact A or B, a stop command is generated.

### • *Cyclic intervals*

With a short manipulation of the switch at the local input 1 contact A or B over the object (1 Bit) an "On" or "Off" telegram is generated. With a long manipulation of the switch at the local input 1 contact A over the object (4 Bit) more brightly is being dimmed as long as the switch is depressed. The dimming step width and the time for more brightness dimming, results out of the parameters "Long operation (dimming)" and "Interval for cyclic dimming". When the switch is released the cyclic sending is stopped.

With a long manipulation of the switch at the local input 1 contact B over the appropriate object (4 Bit) more darkness is dimmed as long as the switch is depressed. The dimming step width and the time for more darkness dimming results out of the parameters "Long operation (dimming)" and "Interval for cyclic dimming". When the switch is released the cyclic sending is stopped.

## Long operation (dimming)

- Options:
- *Adjust by 100 %*
  - *Adjust by 1/2*
  - *Adjust by 1/4*
  - *Adjust by 1/8*
  - *Adjust by 1/16*
  - *Adjust by 1/32*
  - *Adjust by 1/64*

This parameter defines the dimming step width of the telegrams after a long manipulation of the switch at the according input.

△ If "Dimming with cyclic sending" is selected in the parameters, it is to made certain, that the dimming step width is configured together with the parameter "Interval for cyclic dimming" depending on the dimming time of the according actuator.

## Interval for cyclic dimming

- Options:
- *0,5 seconds*
  - *0,5 - 7,0 seconds*

This parameter defines the length of time of an interval for cyclic sending. Example: the dimming time (0 - 100%) in the according switch/dimming actuator is set to 4 seconds, and "Adjust by 1/8" with an "Interval for cyclic dimming" 0,5 seconds is selected. The result is that a dimming command brighter or darker is sent every 0,5 seconds. With a configuration of 8 x 12,5 % and 8 x 0,5 seconds, this matches the dimming speed of the switch/dimming actuator.

### Parameter card „General: Binary input 1...4“

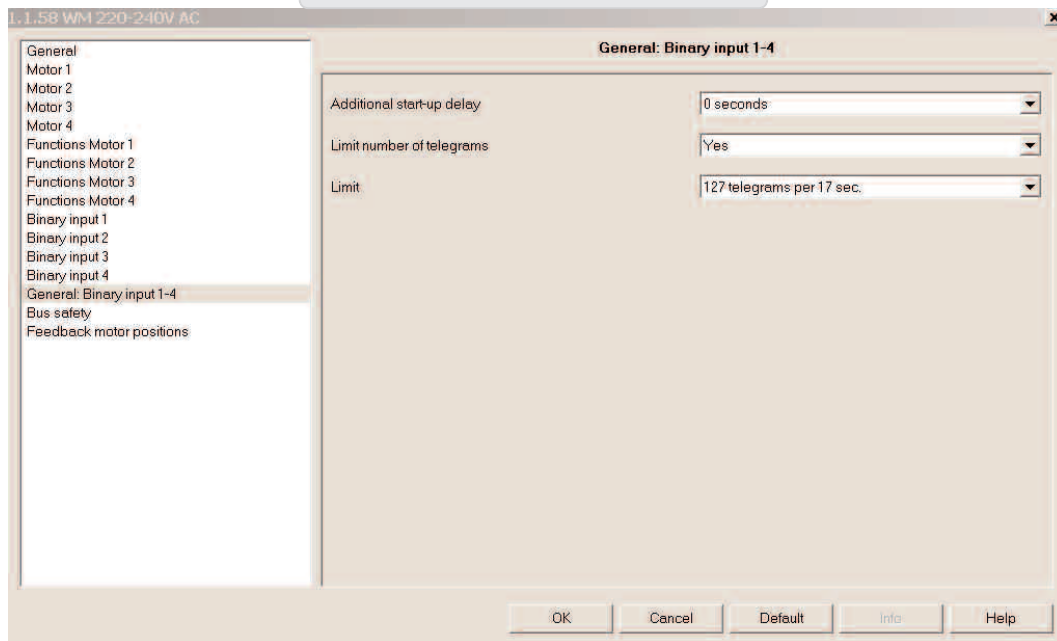

These parameters concern binary inputs 1...4.

#### Start-up delay

- Options:
- 0 seconds
  - 0 - 21 seconds

This parameter defines the time after bus power return which runs off before the first telegram can be sent.

#### Limit number of telegrams

- Options:
- No
  - Yes

If this parameter is set on "Yes" it opens the parameter "Limit" for adjusting the limit of telegrams.

#### Limit

- Options:
- 30 telegrams per 17 sec.
  - 60 telegrams per 17 sec.
  - 100 telegrams per 17 sec.
  - 127 telegrams per 17 sec.

This parameter defines the number of telegrams to be sent within 17 seconds.

## Parameter card „Bus safety“

Parameter	Value
MOTOR 1 Reaction at Bus power failure	Upper end limit
Reaction at Bus power return	Upper end limit
MOTOR 2 Reaction at Bus power failure	Upper end limit
Reaction at Bus power return	Upper end limit
MOTOR 3 Reaction at Bus power failure	Upper end limit
Reaction at Bus power return	Upper end limit
MOTOR 4 Reaction at Bus power failure	Upper end limit
Reaction at Bus power return	Upper end limit
MOTOR 1-4 Reaction at main power return (230V)	Upper end limit
Automatic cascading	No

On this parameter card the reaction can be defined for bus power failure and bus power return of each individual motor output.

### MOTOR 1...4

#### Reaction at bus power failure

- Options:
- *Upper end position*
  - Lower end position
  - Ignore
  - Stop
  - Intermediate position 1
  - Intermediate position 2
  - Close window
  - Open window

This parameter defines the position which will be generated at bus power failure.

### MOTOR 1...4

#### Reaction at bus power return

- Options:
- *Upper end position*
  - Lower end position
  - Ignore
  - Stop
  - Intermediate position 1
  - Intermediate position 2
  - Close window
  - Open window

This parameter defines the position which is generated at bus power return.

### MOTOR 1...4

#### Reaction at main power return (230 V)

- Options:
- *Upper end position*
  - Lower end position
  - Ignore
  - Close window
  - Open window

This parameter defines the position which is generated at main power return (230 V).

### Automatic cascading

- Options:
- *No*
  - Yes

If the parameter "Yes" is selected, each motor output with 1 second of delay will move to the appropriate position. This deceleration time arises considered in the case of "Reaction at Bus power return" and "Reaction at main power return (230V)". The position selected in the parameters for the according motor output will be driven to.

△ Advantage: The current peaks can be lowered thus in larger projects.

## Parameter card "Feedback motor position"

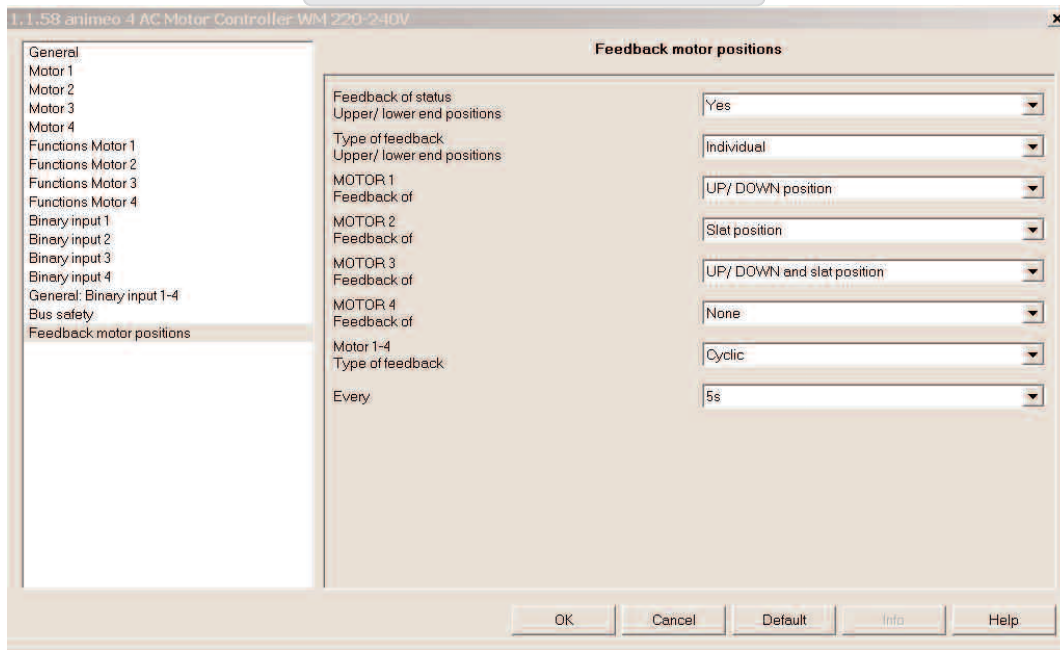

On this parameter card the parameters can be selected in order to announce the status positions of the individual blinds on the bus. The status positions generated thus are based on the configured running and tilting times of the parameter cards "Motor 1...4" or "Motor 1-4".

### Feedback of status Upper/lower end positions

- Options:
- No
  - Yes

This parameter opens the parameter "Type of feedback upper/lower end positions".

### Type of feedback

- Options:
- Combined when all are UP / DOWN
  - Individual

#### • Combined when all are UP / DOWN

If this parameter is selected, the appropriate end position, UP or DOWN, is sent only to the bus when all four blinds have reached the upper end limit (object 50), and respectively when all four end products have reached the lower end position (object 55).

#### • Individual

If this parameter is selected, the appropriate end position, UP or DOWN, is sent to the bus individually for each blind. Two objects are available per motor output (objects 46-49 and 51-54).

### MOTOR 1...4 Feedback for

- Options:
- UP / DOWN position
  - Slat position
  - UP / DOWN and slat position
  - None

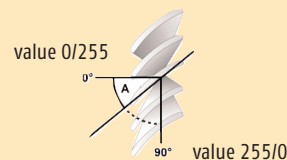

#### • UP / DOWN position

Over this parameter the position UP / DOWN is sent to the bus for the appropriate motor, depending on the parameter "Motor 1-4 type of feedback ". "0" = UP/ "255" = DOWN.

#### • Slat position

Over this parameter the position of the slat is sent to the bus for the appropriate motor, depending on the parameter "Motor 1-4 type of feedback ". "0/255" = slat opened, "255/0" = slat closed.

The value for the slat position which is sent depends on the parameter selection on the parameter card "General, slat position closed/reversed ONLY FOR VENETIAN BLINDS".

• **UP / DOWN and slat position**

Over this parameter the position UP / DOWN and the position of the slat is sent to the bus for the appropriate motor, depending on the parameter "Motor 1-4 type of feedback ". "0/255 "= slat opened, "255/0 "= slat closed

The value for the slat position which is sent depends on the parameter selection on the parameter card "General, slat position closed/reversed ONLY FOR VENETIAN BLINDS".

• **None**

No positions are sent to the bus.

**Type of the feedback**

- Options:
- On demand
  - Status change
  - Cyclic

• **On demand**

The current position of the blinds must be requested over object 45.

• **Status change**

The current position of the appropriate blind is sent to the bus after every change of position. The position is only sent to the bus if the target position is reached.

• **Cyclic**

This parameter opens a further parameter ("Every") in the time for cycling sending is configured.

**Every**

- Options:
- 5 seconds
  - 10 seconds
  - 20 seconds
  - 30 seconds
  - 60 seconds

Over this parameter it is defined in which time intervals the current position of the appropriate blind is sent to the bus.

**6. Diagnosis**

**6.1 LEDs in animeo KNX/EIB Motor Controller**

The LEDs in animeo KNX/EIB Motor Controller can be used for the following functions:

- Operability of the device during operation (230 V / KNX/EIB bus power attached, indication of radio signals, ...)
- A limited overview of the configurations

**6.2 Informations during the operation**

- Receipt of a radio telegram . . . . .
- Security low/high or object "Block functions" active . . . . .
- The device is operational, display of receipt of EIB telegrams . . . . .

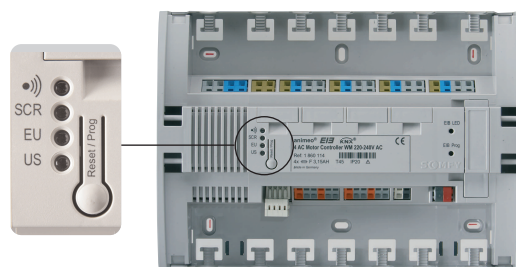

### 6.3 Status of configurations

△ The inquiry of the status of the configurations is only possible on delivery before the device is programmed with the ETS. As soon as the device is programmed with the ETS, the status of the configurations can no longer be checked via the Reset/Prog button. If the device is unloaded by the ETS, the status of the configurations can again be queried over the Reset/Prog button. The inquiry of the status of the radio functionality (green upper LED) is always possible.

LED	On (2 s)	Blinking
•))) = Green	Radio remote configured	No radio configuration
SCR = Yellow	Screen with configured running and tilting times	Screen without configured running and tilting times
EU = Orange	Venetian blind, EU ergonomics, with configured running and tilting times	Venetian blind, EU ergonomics, without configured running and tilting times
US = Red	Venetian blind, US ergonomics, with configured running and tilting times	Venetian blind, US ergonomics, without configured running and tilting times

## 7. Technical Data

The 4 AC Motor Controller animeo KNX/EIB is an electronic operated, independently mounted control with looped-through PE-connection.

4 AC Motor Controller	Art. 1 860 114	Art. 1 860 116
Supply voltage	220 - 240 V AC / 50/60 Hz	220 - 240 V AC / 50/60 Hz
Stand-by current	26 mA @ 230 V	26 mA @ 230 V
Supply voltage from KNX/EIB bus	KNX/EIB voltage 21...30 V DC, SELV	KNX/EIB voltage 21...30 V DC, SELV
Rated current consumption KNX/EIB	as per KNX/EIB guidelines	as per KNX/EIB guidelines
Max. motor current consumption	4 x 3,15 A, $\cos_{\varphi} = 0,95$	4 x 3,15 A, $\cos_{\varphi} = 0,95$
Supply voltage of group control input	SELV, 16 VDC =	SELV, 16 VDC =
Supply voltage of local push buttons	SELV, 16 VDC =	SELV, 16 VDC =
Terminals	Spring connectors	Spring connectors
Terminal KNX/EIB	KNX/EIB bus terminal (black/red)	KNX/EIB bus terminal (black/red)
Running time per output (relay contact)	max. 5 minutes	max. 5 minutes
Fuse per output	4 x 3,15 AH	4 x 3,15 AH
Operation temperature	0° C - 45° C	0° C - 45° C
Relative humidity	85 %	85 %
Material of housing	CC-ABS polycarbonate	CC-ABS polycarbonate
Housing dimensions (H x B x W)	180 x 255 x 63 mm	90 x 210 x 63 mm (12TE)
Degree of protection	IP 20	IP 20
Protection class	II, corresponding to the installation	II, corresponding to the installation
Automatic action	Typ1; Typ 1.C micro interruption	Typ1; Typ 1.C micro interruption
Pollution degree	2	2
Rated impulsive voltage	4 kV	4 kV
Temperature of ball pressure test	75° C	75° C
Conformity	CE by EN 60730	CE by EN 60730

AUSTRALIA  
**SOMFY Pty Limited**  
[www.somfy.com.au](http://www.somfy.com.au)  
Tel.: (61) 2 96 38 07 44

AUSTRIA  
**SOMFY GmbH**  
[www.somfy.at](http://www.somfy.at)  
Tel.: (43) 662 6 25 30 80

BELGIUM  
**SOMFY NV SA**  
[www.somfy.be](http://www.somfy.be)  
Tel.: (32) 27 12 07 70

BRASIL  
**SOMFY BRASIL Ltda**  
[www.somfy.com.br](http://www.somfy.com.br)  
Tel.: (5511) 36 95 35 85

CANADA  
**SOMFY ULC**  
[www.somfysystems.com](http://www.somfysystems.com)  
Tel.: (1) 905 564 6446

CHINA  
**SOMFY China Co Ltd.**  
[www.somfy.com.cn](http://www.somfy.com.cn)  
Tel.: (86) 21 62 80 96 60

CROATIA  
**BFT Adria d.o.o.**  
[www.somfy.com.hu](http://www.somfy.com.hu)  
Tel.: (385) 51 50 26 40

CYPRUS  
**SOMFY Middle East Co. Ltd.**  
[www.somfy.gr](http://www.somfy.gr)  
Tel.: (357) 25 34 55 40

CZECH REPUBLIC  
**SOMFY, spol. s r.o.**  
[www.somfy.cz](http://www.somfy.cz)  
Tel.: (420) 2 96 37 24 86

DENMARK  
**SOMFY Nordic AB Denmark**  
[www.somfy.dk](http://www.somfy.dk)  
Tel.: (45) 65 32 57 93

FINLAND  
**SOMFY Nordic AB**  
[www.somfy.fi](http://www.somfy.fi)  
Tel.: (358) 9 57 130 230

FRANCE  
**SOMFY France**  
[www.somfy.fr](http://www.somfy.fr)  
Tel.: (33) 450 96 70 96

GERMANY  
**SOMFY GmbH**  
[www.somfy.de](http://www.somfy.de)  
Tel.: (49) 7472 93 00

GREAT BRITAIN  
**SOMFY Ltd.**  
[www.somfy.co.uk](http://www.somfy.co.uk)  
Tel.: (44) 11 33 91 30 30

GREECE  
**SOMFY Hellas SA**  
[www.somfy.gr](http://www.somfy.gr)  
Tel.: (30) 210 6 14 67 68

HONG KONG  
**SOMFY Co. Ltd.**  
[www.somfy.com.hk](http://www.somfy.com.hk)  
Tel.: (852) 25 23 63 39

HUNGARY  
**SOMFY Kft**  
[www.somfy.hu](http://www.somfy.hu)  
Tel.: (36) 18 14 51 20

INDIA  
**SOMFY India Pvt Ltd**  
[www.somfy.co.in](http://www.somfy.co.in)  
Tel.: (91) 11 41 65 91 76

ISRAEL  
**SISA HOME AUTOMATION LTD**  
[www.somfy.co.il](http://www.somfy.co.il)  
Tel.: (972) 3 9 52 55 54

ITALY  
**SOMFY Italia S.R.L**  
[www.somfy.it](http://www.somfy.it)  
Tel.: (39) 0 24 84 71 81

JAPAN  
**SOMFY K.K**  
[www.somfy.com/jp](http://www.somfy.com/jp)  
Tel.: (81) 45 481 6800

KOREA  
**SOMFY JOO**  
[www.somfy.co.kr](http://www.somfy.co.kr)  
Tel.: (82) 2 5 94 43 33

KUWAIT  
**SOMFY Kuwait**  
[www.somfy.com.kw](http://www.somfy.com.kw)  
Tel.: (965) 4 34 89 01

LEBANON  
**SOMFY Lebanon**  
[www.somfy.com.lb](http://www.somfy.com.lb)  
Tel.: (961) 1 391 2 24

MEXICO  
**SOMFY MEXICO S.A. de C.V.**  
[www.somfysystems.com](http://www.somfysystems.com)  
Tel.: (52) 55 53 90 56 64

NETHERLANDS  
**SOMFY Nederland B.V**  
[www.somfy.nl](http://www.somfy.nl)  
Tel.: (31) 2 35 54 49 00

NORWAY  
**SOMFY Nordic AB**  
[www.somfy.no](http://www.somfy.no)  
Tel.: (47) 81 50 08 13

POLAND  
**SOMFY Sp. z o. o.**  
[www.somfy.pl](http://www.somfy.pl)  
Tel.: (48) 2 25 09 53 00

PORTUGAL  
**SOMFY Portugal**  
[www.somfy.pt](http://www.somfy.pt)  
Tel.: (351) 2 29 39 68 40

ROMANIA  
**SOMFY SRL**  
[www.somfy.ro](http://www.somfy.ro)  
Tel.: (40) 3 68 44 40 81

RUSSIA  
**SOMFY LLC**  
[www.somfy.ru](http://www.somfy.ru)  
Tel.: (7) 49 57 81 47 72

KINGDOM OF SAUDI ARABIA  
**SOMFY Jeddah**  
[www.somfy.com.sa](http://www.somfy.com.sa)  
Tel.: (966) 26 98 33 53

SERBIA  
**MIGRO**  
[www.somfy.co.yu](http://www.somfy.co.yu)  
Tel.: (381) 25 84 15 10

SINGAPORE  
**SOMFY PTE LTD**  
[www.somfy.com.sg](http://www.somfy.com.sg)  
Tel.: (65) 63 83 38 55

SPAIN  
**SOMFY España S.A.**  
[www.somfy.es](http://www.somfy.es)  
Tel.: (34) 9 34 80 09 00

SWEDEN  
**SOMFY Nordic AB**  
[www.somfy.se](http://www.somfy.se)  
Tel.: (46) 40 16 59 00

SWITZERLAND  
**SOMFY AG**  
[www.somfy.ch](http://www.somfy.ch)  
Tel.: (41) 44 8 38 40 30

TAIWAN  
**SOMFY Development  
Taiwan Branch**  
[www.somfy.com.tw](http://www.somfy.com.tw)  
Tel.: (886) 2 85 09 89 34

TURKEY  
**SOMFY EV OTOMASYON  
SISTEMLERI LTD STI**  
[www.somfy.com.tr](http://www.somfy.com.tr)  
Tel.: (90) 21 66 51 30 15

USA  
**SOMFY Systems Inc.**  
[www.somfysystems.com](http://www.somfysystems.com)  
Tel.: (1) 609 395 1300